

Imaging

Imaging

1

ENDOCAM

2

Accessories

3

Lenses

4

Monitors

5

Light sources

6

Light cables

7

Adapters

8

Documentation

9

Device carts

ENDOCAM Logic 4K

Camera controller



- 4K resolution with either 3840 x 2160 pixels or 4096 x 2160 pixels
- Continuous processing of captured 4K imaging data with 4K resolution
- Optimally matched system consisting of telescopes, lenses, camera head, camera controller, light source, light cables and monitors
- All available light sources and applied parts of the ENDOCAM Logic HD are compatible with the ENDOCAM Logic 4K Controller and can continue to be used
- Dialog function:
 1. Control of connected, dialog-capable ENDOLIGHT light source for optimum illumination with maximum protection for the endoscope
 2. Monitor display of major parameters for further devices (e.g. pressure indication, set flow, residual gas display)
- USB port on camera controller for directly saving HD images and HD videos to USB storage media
- Including "Special Imaging Modes" (SIM) for enhanced tissue differentiation
- Extremely easy to use thanks to pre-programming of clinically-devised presets for various disciplines, effortless saving of personal settings
- Patient data can be entered via a USB keyboard
- Direct printing possible
- Future-proof investment, updates can be imported at any time via the USB port
- Central component of the **core nova** OP Integration

ENDOCAM Logic 4K camera controller

bndl **55253011**

Comprising:

1x ENDOCAM Logic 4K camera controller	5525301
1x hand-held remote control	5525401
1x USB flash memory 32GB	72321829
1x HDMI/HDMI cable, lockable, 3.0 m	103847
1x power cable	2440.03

ENDOCAM Logic 4K

Technical data of camera controller

Camera controller		5525301			
Device properties					
Type of controls	Touchscreen				
Max. video signal resolution	4096 x 2160 pixels				
White balance, color temperature range	2300 K to 7000 K				
Noise level	34 dB to 48 dB max.				
Digital zoom	1.5x max.				
Individually configurable profiles	at least 5 profiles				
Brightness control	Automatic shutter control + automatic gain control				
Image format of saved pictures / videos	JPEG, TIFF (max. 1920 x 1200) / MPEG4 (max. 1920 x 1080/60P)				
Operating conditions	+10°C to +40°C, 30% to 75% rel. humidity, atmospheric pressure 700 hPa to 1060 hPa				
Operating mode	Continuous operation				
Equipment					
IP rating	IP20				
Cooling method	Controlled fan				
Power supply					
Mains + frequency	100-240 VAC, 50/60 Hz				
Power consumption	120 VA				
Current rating	max. 1.2 A				
Regulatory standards					
Safety	US/ CA: UL 2601-1 / CSA C22.2 NO.601.1, EU: EN 60601				
EMC	EN 60601-1-2 / IEC 601-1-2				
Medical device class	Class 1				
Classification of applied part	CF				
Interfaces					
Video outputs	2x HDMI 4K, 2x HDMI HD, 2x 3G-HD-SDI				
PiP input	1x 3G-HD-SDI				
Remote output	2 x 3.5 mm jack, stereo				
USB port (on front panel, for external storage media)	USB 2.0 (FAT32/NTFS formatting)				
Resolution (HDMI output)	Adjustable in the user menu				
	1280 x 1024/60P (5:4)		Only for HDMI 4K:		
	1920 x 1080/60P (16:9)		4K 3840 x 2160/60P (16:9)		
Resolution (3G-HD-SDI output)	Adjustable in the user menu				
	1280 x 720/50P (16:9)	1920 x 1080/50I (16:9)	1920 x 1080/50P (16:9)		
	1280 x 720/60P (16:9)	1920 x 1080/50I (16:9)	1920 x 1080/60P (16:9)		
Resolution of picture-in-picture input (3G-SDI)	1280 x 720/50P (16:9)	720 x 486/60I (16:9)	1920 x 1080/50P (16:9)	1920 x 1080/50I (16:9)	
	1280 x 720/60P (16:9)	720 x 576/50I (16:9)	1920 x 1080/60P (16:9)	1920 x 1080/60I (16:9)	
Dimensions and weights					
Weight	6.2 kg				
Dimensions (W x H x D)	300 x 120 x 416 mm				

ENDOCAM Logic 4K

3-chip 4K camera head

1 ENDOCAM



- Digital image processing and digital signal transmission
- 2 programmable camera head buttons with 4 available functions
- Ergonomic handling due to smaller, weight-saving design compared to previous HD camera heads
- Production using 3D printer
- Improved heat dissipation makes the device more pleasant to handle
- Universal C-Mount lens connection
- Service-friendly design: camera cable can be replaced on site by technician
- Steam-sterilizable
- Can be reprocessed by machine
- Suitable for low-temperature procedure

ENDOCAM Logic 4K camera head **85525942**
3-chip type, cable length 3 m

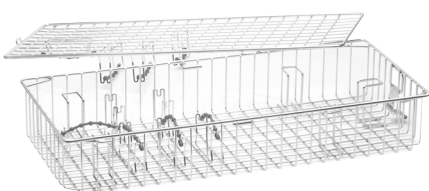
Recommended accessories	Product no.
	<p>Reprocessing basket for camera head (L x W x H) 445 x 200 x 73 mm</p> <p>38047111</p>

ENDOCAM Logic 4K

Technical data of camera head

Camera head		85525942
Device properties		
Sensor	3x 1/3" CMOS	
Operation	2 programmable head buttons with 4 functions	
Operating conditions	+10°C to +30°C, 20% to 75% rel. humidity, atmospheric pressure 700 hPa to 1060 hPa	
Equipment		
Thread for objective lens	C-Mount	
Degree of protection against the ingress of moisture	IPX7	
Service	Camera head cable and eyepiece snap-in coupling can be replaced on site	
Dimensions and weight		
Camera head weight (without cable)	121 g	
Housing dimensions (W x H) - without cable and anti-kink protection	40 x 47 mm	
Camera head length (without cable)	102 mm	
Cable length	3 m	
Cable outlet	30°	

ENDOCAM Logic 4K Lenses

RIWO lens with snap-on mechanism and C-Mount thread, steam-sterilizable and reprocessable by machine		Product no.
 <p>AUTOCLAVE 134° C / 273° F</p>	<p>RIWO lens f = 14 mm</p>	85261144
	<p>RIWO lens f = 24 mm</p>	85261244
RIWO zoom lens with snap-on mechanism and C-Mount thread, steam-sterilizable and reprocessable by machine		
 <p>AUTOCLAVE 134° C / 273° F</p>	<p>RIWO zoom lens f = 13-29 mm</p>	85261504
RIWO angular lens with rotatable snap-on mechanism and C-Mount thread, suspension function, suitable for reprocessing by machine and low-temperature procedure		
	<p>RIWO angular lens f = 14 mm</p>	5257141
	<p>RIWO angular lens f = 17 mm</p>	5257171

V19 || Subject to modifications. Please note that some products may not be available in all countries. For more detailed information, please consult with your contact partner or directly with Richard Wolf GmbH.

ENDOCAM Logic 4K

Compatible applied parts and camera heads from the ENDOCAM Logic family



- ENDOCAM Logic 4K camera head 3-chip (85525942)
- ENDOCAM Logic HD camera head 3-chip (85525922/923)
- ENDOCAM Logic HD camera head 1-chip (85525902)
- Pendual camera head ENDOCAM Logic HD (5525933)
- Pendual camera head **blue** ENDOCAM Logic HD (5525833)
- Flexible sensor ureterorenoscope "COBRA Vision" (7356071/076)
- Flexible sensor ureterorenoscope "BOA Vision" (7355071/076)
- Flexible sensor cystoscope "MAMBA Vision" (7315001/006)

ENDOCAM Logic 4K

Overview

ENDOCAM Logic 4K Camera Controller

bndl 55253011

Comprising:

1x ENDOCAM Logic 4K Camera Controller 5525301
 1x hand-held remote control USB 5525401
 1x USB flash memory 32GB 72321829
 1x HDMI/HDMI cable, lockable, 3.0 m 103847
 1x power cable 2240.03

ENDOCAM Logic 4K camera head 85525942

RIWO lenses, C-Mount

f = 14 mm 85261144
 f = 24 mm 85261244
 f = 13 - 29 mm 85261504

RIWO zoom lens, C-Mount

f = 13 - 29 mm 5261504

Light source LED 2.2 bndl 51640011

Comprising:

1x ENDOLIGHT LED 2.2, 80 W 5164001
 1x patch cable, RJ45 SFTP, 0.5m 72325378
 1x power cable 2440.03

PANOVIEW ULTRA telescope, Ø 5.5 mm,

WL 300 mm
 0° 8935461
 30° 8935462
 WL 430 mm
 0° 89354416
 30° 89354426

PANOVIEW ULTRA telescope, Ø 10 mm,

WL 305 mm
 0° 8934461
 30° 8934462
 50° 8934463
 WL 440 mm
 0° 89344416
 30° 89344426
 50° 89344436

Fusion fiber light cable, bndl, Ø 5.0 mm

2.3 m 806550231
 3.0 m 806550301
 3.5 m 806550351

Comprising:

1x adapter, projector to light cable 8095.07
 1x adapter, light cable to endoscope 809509
 1x Fusion fiber light cable 806550xx

LCD monitor 4K

31" LMD-X310NB
 55" LMD-X550NB

Protective cover for monitor

31" 53700031
 55" 53700055

Flightcase

for 55" monitor 155831669

Mini Cleanboard USB

wipe-clean USB keyboard incl. mouse pad
 German (QWERTZ) 103823
 US/English (QWERTY) 103824

Digital color printer SONY UP-DR80MD 5651051

Color photo print package DIN-A4 UPC-R80MD 5651926

4K signal channel for distances greater than 5 m

DTP transmitter DTP HDMI 4K 330 TX
 DTP receiver DTP HDMI 4K 330 RX
 Cable HDMI / HMDI 0.5 m HDMI-MM-0.5MG-UF
 Medical-grade power supply unit 36 W PS 1230 MD
 Shielded twisted-pair cable 0.9 m XTP DTP 24/3
 Shielded twisted-pair cable 7.6 m XTP DTP 24/25
 Shielded twisted-pair cable 22.4 m XTP DTP 24/75
 Shielded twisted-pair cable 30.4 m XTP DTP 24/100

ENDOCAM Logic 4K

System overview

ENDOCAM

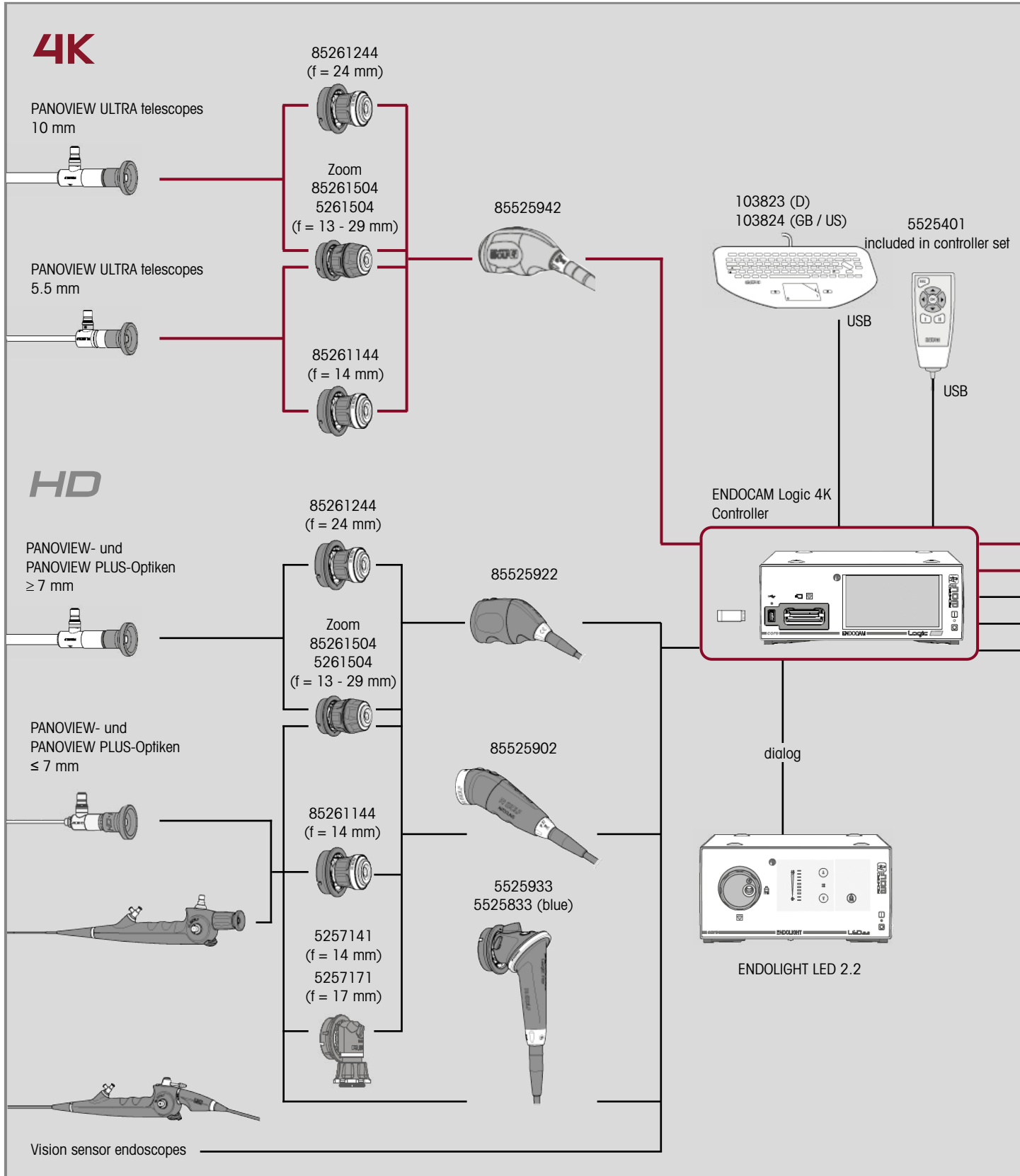

V19 || Subject to modifications. Please note that some products may not be available in all countries. For more detailed information, please consult with your contact partner or directly with Richard Wolf GmbH.

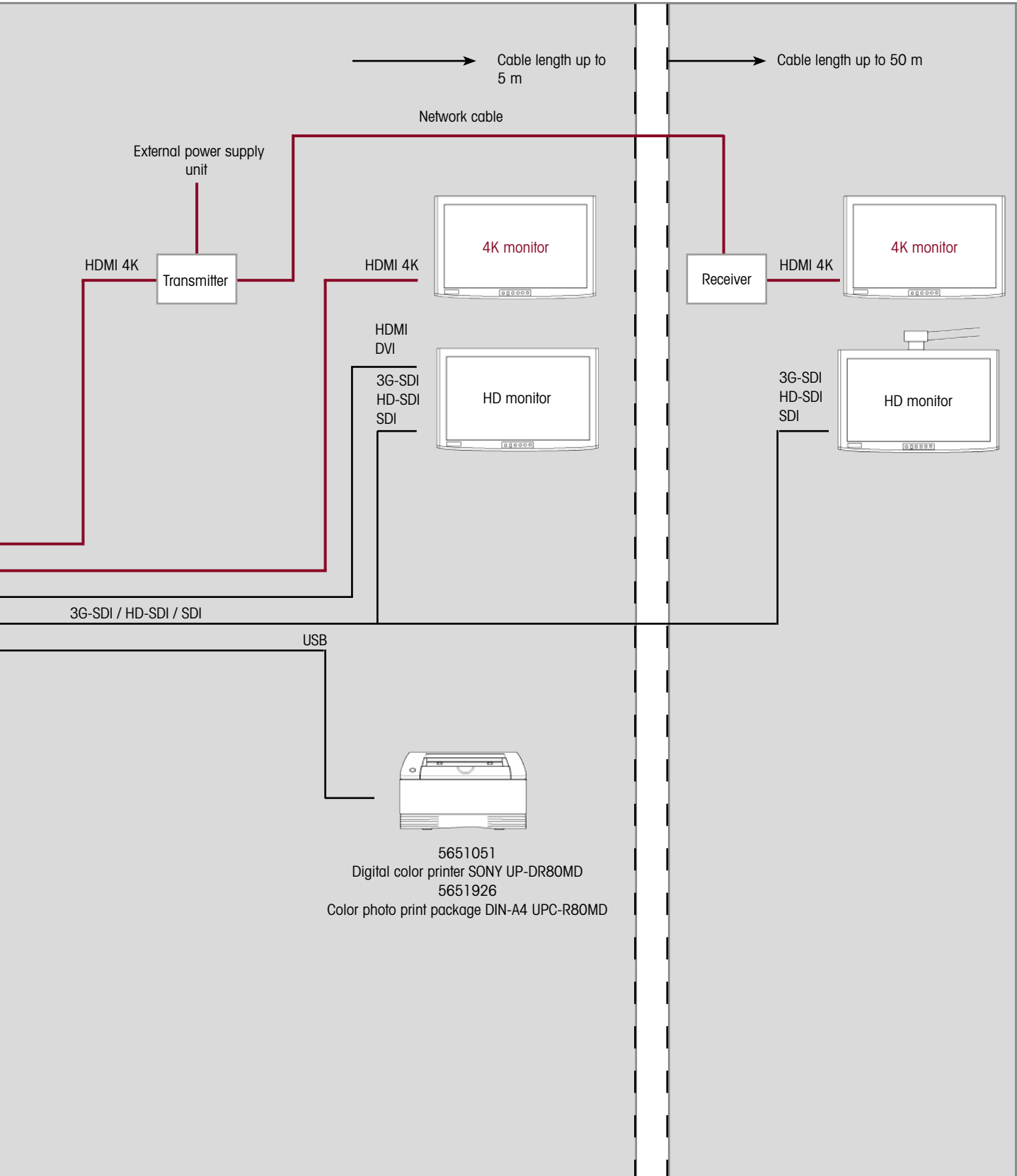

V19 || Subject to modifications. Please note that some products may not be available in all countries.
For more detailed information, please consult with your contact partner or directly with Richard Wolf GmbH.

ENDOCAM Logic HD

Camera controller



- Various equipment variants. The variants exclusively refer to the configuration of output and input signals
- Digital signal processing
- Outstandingly wide range of application due to integration of various applied parts and diagnostic methods
- updates can be applied at any time via USB port
- Storage of high-resolution images and HD videos on USB storage media
- Integration of further image signals via picture-in-picture port (3G-SDI)
- Specialized for use in integrated operating rooms as a central **core nova module**

- User-friendly. Clinically-devised presets are pre-programmed for various disciplines. This includes applications using standard and fiber endoscopes as well as sensor endoscopes with chip-on-the-tip technology. Personal settings can easily be saved as well
- Maximum flexibility: The resolution of all signal outputs can be adapted individually to the connected system
- Patient data can be entered using the connected USB keyboard
- Direct printing possible
- Modern, clearly arranged on-screen menu
- Dialog function:
 1. Control of connected ENDOLIGHT light source for optimum illumination with maximum protection for the endoscope
 2. Monitor display of major device parameters for further devices (pressure indication, set flow, residual gas display, etc.)

ENDOCAM Logic HD controller bnd1

Comprising:

1x ENDOCAM Logic HD controller	552510x
1x hand-held remote control USB	5525401
1x USB flash memory 8 GB	56540028
1x CAN-BUS terminator	5590.989
1x HDMI / DVI-D cable, lockable, 3.0 m	103843
1x power cable	2440.03

Controller equipment variants:

2x HDMI out	55251011
2x HDMI out / 2x 3G-SDI out	55251051
2x HDMI out / 2x 3G-SDI out / PIP in	55251061
2x HDMI out / 2x 3G-SDI out / analog out	55251071
2x HDMI out / 2x 3G-SDI out / PIP in / analog out	55251081

ENDOCAM Logic HD

Technical data of camera controller

Camera controller		552510x		
Device properties				
Type of controls	Touchscreen			
Max. video signal resolution	1920 x 1200 pixels			
White balance, color temperature range	2300 K to 7000 K			
Noise level	34 dB to 48 dB max.			
Digital zoom	1.5x max.			
Individually configurable profiles	at least 5 profiles			
Brightness control	Automatic shutter control + automatic gain control			
Image format of saved pictures / videos	JPEG, TIFF (max. 1920 x 1080) / MPEG4 (max. 1920 x 1080)			
Operating conditions	+10°C to +40°C, 30% to 75% rel. humidity, atmospheric pressure 700 hPa to 1060 hPa			
Operating mode	Continuous operation			
Equipment				
IP rating	IP20			
Cooling method	Controlled fan			
Power supply				
Mains + frequency	100-240 VAC, 50/60 Hz			
Power consumption	100 VA			
Current rating	max. 1.0 A			
Regulatory standards				
Safety	US/ CA: UL 2601-1 / CSA C22.2 NO.601.1, EU: EN 60601			
EMC	EN 60601-1-2 / IEC 601-1-2			
Medical device class	Class 1			
Classification of applied part	CF			
Interfaces				
Video outputs	2x 3G-SDI, 2x HDMI, 1x YC, 1x CV			
PiP input	1x 3G-HD-SDI			
Remote output	2 x 3.5 mm jack, stereo			
USB port (on front panel, for external storage media)	USB 2.0 (FAT32/NTFS formatting)			
Resolution (HDMI output)	Adjustable in the user menu 1280 x 1024/60P (5:4) 1920 x 1080/60P (16:9) 1920 x 1200/60P (16:10)			
Resolution (3G-SDI output) also supports HD-SDI	Adjustable in the user menu 1280 x 720/50P (16:9) 1920 x 1080/50I (16:9) 1920 x 1080/50P (16:9) 1280 x 720/60P (16:9) 1920 x 1080/60I (16:9) 1920 x 1080/60P (16:9)			
Resolution of SD outputs for video (Composite) and S-Video (Y/C)	Adjustable in the user menu PAL 720 x 576/50I (4:3) NTSC 720 x 486/59.94I (4:3)			
Resolution of picture-in-picture input (3G-SDI)	1280 x 720/50P (16:9) 1920 x 1080/50I (16:9) 1920 x 1080/50P (16:9) 1280 x 720/60P (16:9) 1920 x 1080/60I (16:9) 1920 x 1080/60P (16:9)			
Dimensions and weights				
Weight	6.2 kg			
Dimensions (W x H x D)	300 x 120 x 416 mm			

ENDOCAM Logic HD

3-chip HD camera head

1 ENDOCAM



- Digital image processing and digital signal transmission
- 2 programmable camera head buttons with 4 available functions
- Universal C-Mount lens connection
- Cable outlet angled at 30°
- Camera head cable can be replaced in the hospital by technicians
- Steam-sterilizable
- Can be reprocessed by machine
- Suitable for low-temperature procedure

ENDOCAM Logic HD camera head **85525922**
3-chip type, cable length 3 m

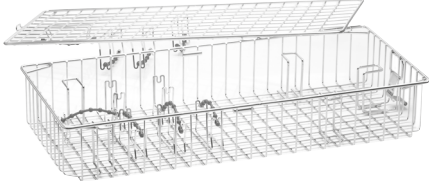
Recommended accessories		Product no.
RIWO lens	C-Mount, f = 14 mm	85261144
	C-Mount, f = 24 mm	85261244
RIWO zoom lens	C-Mount, f = 13 - 29 mm	85261504
	Reprocessing basket for camera head (L x W x H) 445 x 200 x 73 mm	38047111

ENDOCAM Logic HD

Technical data of camera head

Camera head		85525922
Device properties		
Sensor	3x 1/3" CCD	
Operation	2 programmable head buttons with 4 functions	
Operating conditions	+10°C to +30°C, 20% to 75% rel. humidity, atmospheric pressure 700 hPa to 1060 hPa	
Equipment		
Thread for objective lens	C-Mount	
Degree of protection against the ingress of moisture	IPX7	
Service	Cable and eyepiece snap-in coupling can be replaced on site	
Dimensions and weight		
Camera head weight (without cable)	170 g	
Housing dimensions (W x H) - without cable and anti-kink protection	43 x 53 mm	
Camera head length (without cable)	105 mm	
Cable length	3 m / 5 m	
Cable outlet	30°	

ENDOCAM Logic HD

1-chip HD camera head

ENDOCAM

1



- Digital image processing and signal transmission
- 2 programmable camera head buttons with 4 available functions
- Universal C-Mount lens connection
- Cable outlet angled at 30°
- Camera head cable can be replaced in the hospital by technicians
- Steam-sterilizable
- Can be reprocessed by machine
- Suitable for low-temperature procedure

ENDOCAM Logic HD camera head **85525902**

1-chip type, cable length 3 m

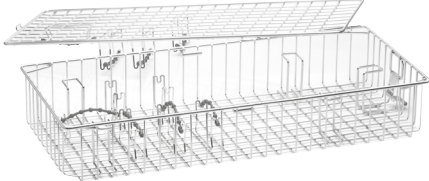
Recommended accessories		Product no.
RIWO lens	C-Mount, f = 14 mm	85261144
	C-Mount, f = 24 mm	85261244
RIWO zoom lens	C-Mount, f = 13 - 29 mm	85261504
	Reprocessing basket for camera head (L x W x H) 445 x 200 x 73 mm	38047111

ENDOCAM Logic HD

Technical data of camera head

ENDOCAM
1

Camera head		85525902
Device properties		
Sensor	1x1/3" CCD	
Operation	2 programmable head buttons with 4 functions	
Operating conditions	+10°C to +35°C, 20% to 75% rel. humidity, atmospheric pressure 700 hPa to 1060 hPa	
Equipment		
Thread for objective lens	C-Mount	
Degree of protection against the ingress of moisture	IPX7	
Service	Cable and eyepiece snap-in coupling can be replaced on site	
Dimensions and weight		
Camera head weight (without cable)	110 g	
Housing dimensions (W x H) - without cable and anti-kink protection	34 x 36 mm	
Camera head length (without cable)	114 mm	
Cable length	3 m	
Cable outlet	30°	

System green
Camera head green
for the NIR/ICG Application



- Compatible with ENDOCAM Logic 4K und HD
- 2 programmable camera head buttons with 4 available functions
- Autoclavable camera head
- Use in NIR / ICG fluorescence endoscopy and in standard white light endoscopy
- Integrated lens
- Digital image processing and signal transmission
- Snap-on mechanism with locking function

ENDOCAM
Logic HD camera head green **85525812**
2-chip, cable length 3 m

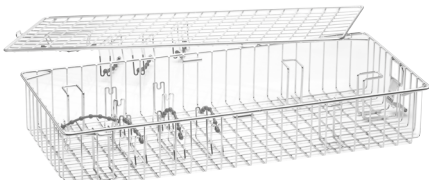
Recommended accessories	Product no.
	<p>Reprocessing basket for camera head (L x W x H) 445 x 200 x 73 mm</p>
	<p>38047111</p>

System green

Technical data camera head green

Camera head		85525812
Device properties		
Sensor	1/3" CMOS	
Operation	2 programmable head buttons with 4 functions	
Focal length range integrated lens	24 mm	
Operating conditions	+10°C to +30°C, 20% to 85% rel. humidity, atmospheric pressure 700 hPa to 1060 hPa	
Equipment		
Degree of protection against the ingress of moisture	IPX7	
Service	Cable and eyepiece snap-in coupling can be replaced on site	
Dimensions and weight		
Camera head weight (without cable)	196 g	
Housing dimensions (W x H) - without cable and anti-kink protection	48 x 48 x 136 mm	
Camera head length (without cable)	136 mm	
Cable length	3 m	
Cable outlet	30°	

System blue

Pendual camera head blue

For photodynamic diagnostics (PDD)



- Suitable for ENDOCAM Logic 4K und HD Camera Controller
- Integrated filter for PDD applications
- Bendable housing for two application modes:
1: pivoting camera head, 2: straight camera head
- Freely rotating snap-on mechanism with lock function
- Integrated lens $f = 15 \text{ mm}$

- Digital image processing and signal transmission
- 2 programmable camera head buttons with 4 available functions
- Camera head cable can be replaced in the hospital by technicians
- Can be reprocessed by machine
- Suitable for low-temperature procedure

ENDOCAM Logic HD

Pendual camera head blue 5525833

1-chip type, cable length 3 m

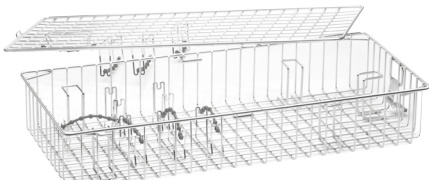
Recommended accessories	Product no.	
	<p>Reprocessing basket for camera head (L x W x H) 445 x 200 x 73 mm</p>	<p>38047111</p>

System blue

Technical data of pendul camera head blue

Camera head		5525833
Device properties		
Sensor	1x 1/3" CMOS	
Operation	2 programmable head buttons with 4 functions	
Focal length range with integrated lens	15 mm	
Operating conditions	+10°C to +30°C, 30% to 75% rel. humidity, atmospheric pressure 700 hPa to 1060 hPa	
Equipment		
Degree of protection against the ingress of moisture	IPX7	
Service	Cable and eyepiece snap-in coupling can be replaced on site	
Handling	Pendulum housing can be converted into an axial camera head simply by rotating	
Dimensions and weight		
Camera head weight (without cable)	175 g	
Housing dimensions (W x H) - without cable and anti-kink protection	51 x 50 mm	
Camera head length (without cable)	141 mm	
Cable length	3 m	
Cable outlet	0°	

ENDOCAM Logic HD

Pendual camera head



- Bendable housing for two operating modes:
1: pivoting camera head, 2: straight camera head
- Freely rotating snap-on mechanism with lock function
- Integrated lens $f = 17 \text{ mm}$
- Digital image processing and signal transmission
- 2 programmable camera head buttons with 4 available functions
- Camera head cable can be replaced in the hospital by technicians
- Can be reprocessed by machine
- Suitable for low-temperature procedure

ENDOCAM Logic HD pendual camera head 5525933

1-chip type, cable length 3 m

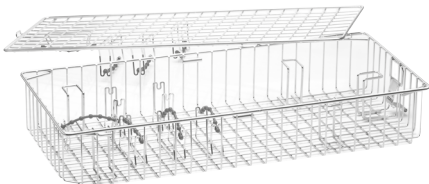
Recommended accessories	Product no.	
	<p>Reprocessing basket for camera head (L x W x H) 445 x 200 x 73 mm</p>	<p>38047111</p>

ENDOCAM Logic HD

Technical data of pendul camera head

Camera head		5525933
Device properties		
Sensor	1x 1/3" CCD	
Operation	2 programmable head buttons with 4 functions	
Focal length range with integrated lens	17 mm	
Operating conditions	+10°C to +40°C, 30% to 75% rel. humidity, atmospheric pressure 700 hPa to 1060 hPa	
Equipment		
Degree of protection against the ingress of moisture	IPX7	
Service	Cable and eyepiece snap-in coupling can be replaced on site	
Handling	Pendulum housing can be converted into an axial camera head simply by rotating	
Dimensions and weight		
Camera head weight (without cable)	175 g	
Housing dimensions (W x H) - without cable and anti-kink protection	51 x 50 mm	
Camera head length (without cable)	141 mm	
Cable length	3 m	
Cable outlet	0°	

ENDOCAM Logic HD lite

Camera controller

1 ENDOCAM



ENDOCAM Logic HD Lite camera controller

bndl **55252011**

Comprising:

- 1x ENDOCAM Logic HD Lite camera controller 5525201
- 1x hand-held remote control USB 5525401
- 1x USB flash memory 8GB 56540028
- 1x HDMI / DVI-D cable, lockable 3.0 m 103843
- 1x power cable 2440.03
- 1x 5525 DVD license open-source software 64360816

- Maximum quality at a minimum price
- Basic functions
- User-friendly

ENDOCAM Logic HD lite

Technical data of camera controller

Camera controller		5525201	
Device properties			
Type of controls	Mechanical button		
Max. video signal resolution	1920 x 1200 pixels		
White balance, color temperature range	2300K to 7000K		
Noise level	34 dB to 48 dB max.		
Digital zoom	1.5x max.		
Individually configurable profiles	at least 5 profiles		
Brightness control	Automatic shutter control + automatic gain control		
Image format of saved pictures / videos	JPEG, TIFF (max. 1920 x 1080)		
Operating conditions	+10°C to +40°C, 30% to 75% rel. humidity, atmospheric pressure 700 hPa to 1060 hPa		
Operating mode	Continuous operation		
Equipment			
IP rating	IP 20		
Cooling method	Controlled fan		
Power supply			
Mains + frequency	100 - 240 VAC, 50 / 60 Hz		
Power consumption	100 VA		
Current rating	max. 1.0 A		
Regulatory standards			
Safety	US/ CA: UL 2601-1 / CSA C22.2 NO.601.1, EU: EN 60601		
EMC	EN 60601-1-2 / IEC 601-1-2		
Medical device class	Class 1		
Classification of applied part	CF		
Interfaces			
Video outputs	2x HDMI		
Remote output	2 x 3.5 mm jack, stereo		
USB port (on front panel, for external storage media)	USB 2.0 (FAT32/NTFS formatting)		
Resolution (HDMI output)	Adjustable in the user menu 1280 x 1024/60P (5:4) 1920 x 1080/60P (16:9)		1920 x 1200/60P (16:10)
Dimensions and weights			
Weight	5.2 kg		
Dimensions (W x H x D)	300 x 120 x 416 mm		

ENDOCAM Logic HD

System overview

ENDOCAM

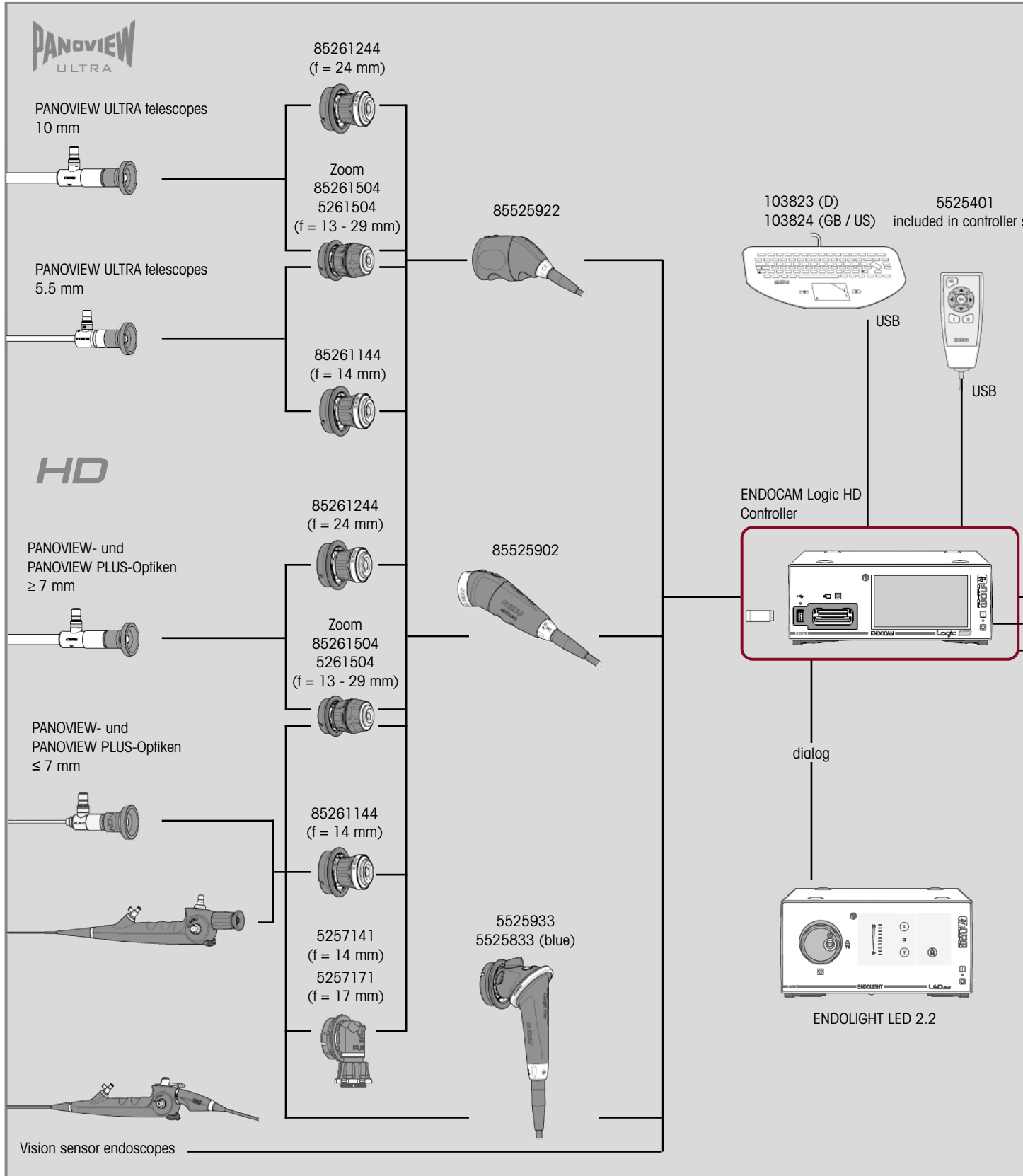

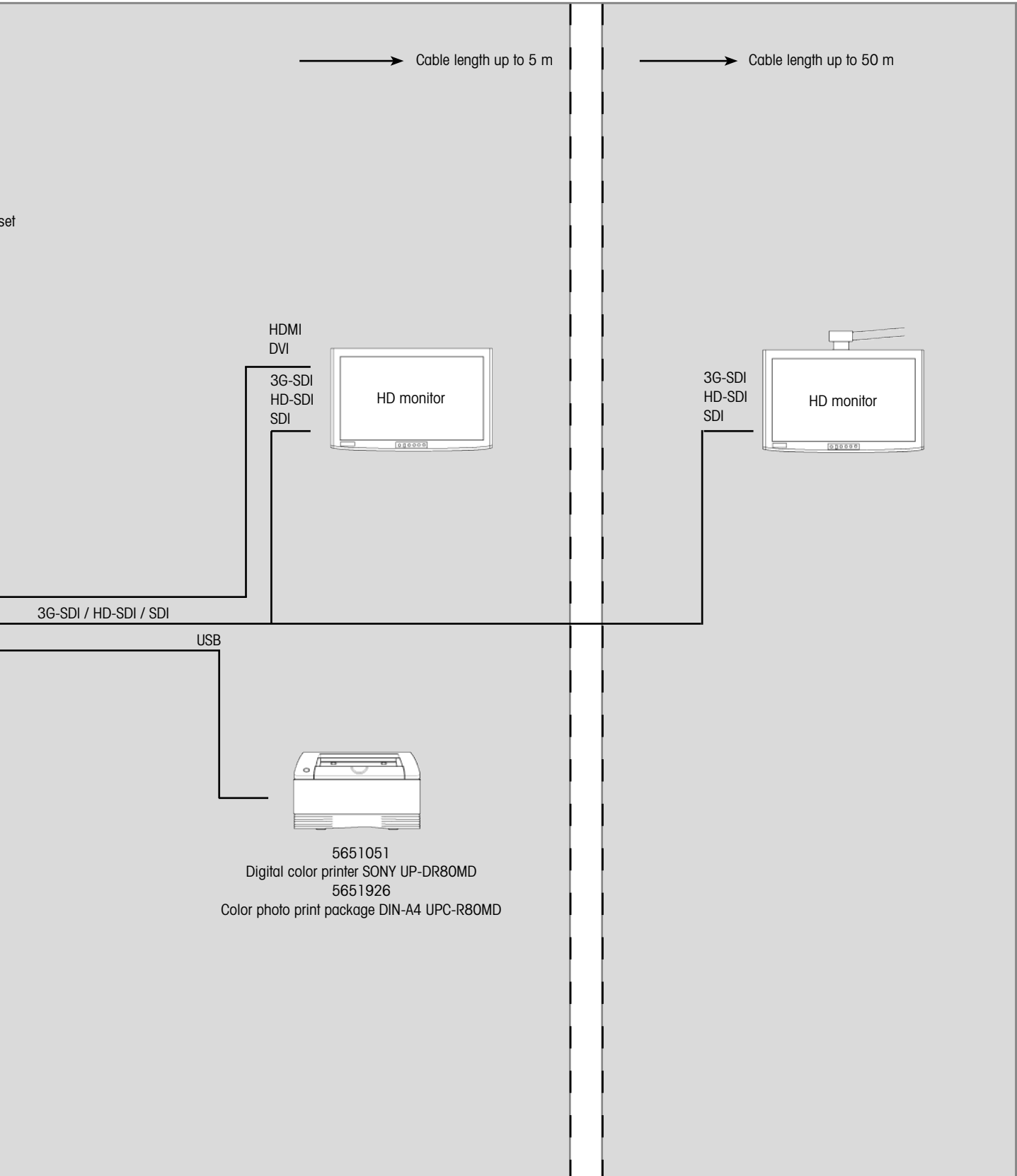

V19 || Subject to modifications. Please note that some products may not be available in all countries. For more detailed information, please consult with your contact partner or directly with Richard Wolf GmbH.



V19 || Subject to modifications. Please note that some products may not be available in all countries.
For more detailed information, please consult with your contact partner or directly with Richard Wolf GmbH.

ENDOCAM Logic

Camera controller comparison

Camera controller				
	ENDOCAM Logic HD		ENDOCAM Logic HD lite	ENDOCAM Logic 4K
				
	Product no.			
Properties	55251011	With 3G-SDI output 55251051 55251061 55251071 55251081	55252011	55253011
Saving of single images to USB memory stick (image archive)	●	●	●	●
Saving of videos to USB memory stick (video archive)	-	●	-	●
Entry of patient data via keyboard	●	●	●	●
Touchscreen	●	●	-	●
On-screen display	●	●	●	●
Compatible with core nova	●	●	●	●
<i>Dialog</i> function via Ethernet	●	●	●	●
Mirroring of images	●	●	-	●
4K signal processing	-	-	-	●
Special Imaging Modes	●	●	●	●
PDD functionality	●	●	-	●
NIR / ICG functionality	●	●	-	●
Connection of flexible endoscopes	●	●	●	●
Picture-in-picture input (only applies to 5525106 and 5525108)	-	●	-	●

ENDOCAM Performance HD

Camera controller

ENDOCAM
1



- Optimized for connection to LCD monitors via HDMI
- Digital SDI output makes signal transmission possible across long distances
- Analog signal processing
- USB port on camera controller for direct saving of SD images and HD videos to USB storage media
- Remote control functions via Remote output (e.g. switching light source ENDOLIGHT LED 1.2 to stand-by or actuating an external color printer)

- Manual adjustment of measuring window to control imaging brightness
- Various digital contrast gains incl. anti-moiré setting
- Automatic, electronic shutter control for optimized image brightness
- Soft Touch – "easy clean" front panel surface
- Clearly arranged, easy operation
- Meets all hygienic requirements in daily operation

ENDOCAM Performance HD 50Hz bndl 5514001



Comprising:

- 1x ENDOCAM Performance HD camera controller 5514101
- 1x ENDOCAM Performance camera head cable, 4 m 5514901
- 1x USB flash memory 8 GB 56540028
- 1x HDMI / DVI-D cable, lockable, 3.0 m 103843
- 1x remote control cable, 1.5 m 5502.991
- 1x power cable 2440.03

ENDOCAM Performance HD 60Hz bndl 5514601

Comprising:

- 1x ENDOCAM Performance HD camera controller 5514101
- 1x ENDOCAM Performance camera head cable, 4 m 5514961
- 1x USB flash memory 8 GB 56540028
- 1x HDMI / DVI-D cable, lockable 3.0 m 103843
- 1x remote control cable, 1.5 m 5502.991
- 1x power cable 2440.03

Recommended accessories	Product no.	
	LED light sources	see section 6 - Light sources
	LCD monitor MDRAP21ELXACRW3	see section 4 - Monitors

ENDOCAM Performance HD

Technical data of camera controller

Camera controller		5514101	
Device properties			
Type of controls	mechanical buttons		
Max. video signal resolution	1920 x 1080 pixels		
White balance, color temperature range	2300 K to 7000 K		
Noise level	Noiseless, as no fan installed		
Brightness control	Automatic shutter control 1/60 s to 1/10,000 s		
Image format of saved pictures / videos	BMP / MPEG4		
Operating conditions	+10°C to +40°C, 30% to 75% rel. humidity, atmospheric pressure 700 hPa to 1060 hPa		
Operating mode	Continuous operation		
Equipment			
IP rating	IP20		
Cooling method	Passive		
Power supply			
Mains + frequency	100 - 240 VAC, 50 / 60 Hz		
Power consumption	40 VA		
Current rating	max. 0.25 A		
Regulatory standards			
Safety	US/ CA: UL 2601-1 / CSA C22.2 NO.601.1, EU: EN 60601		
EMC	EN 60601-1-2 / IEC 601-1-2		
Medical device class	Class 1		
Classification of applied part	CF		
Interfaces			
Video outputs	1x SDI, 2x S-Video, 1x YPbPr, 1x HDMI		
Remote output	1x 3.5 mm jack, stereo		
USB port (on front panel, for external storage media)	USB 2.0 (FAT32/NTFS formatting)		
Resolution (HDMI output)	Adjustable via DIP switches on housing rear		
	1920 x 1080i (16:9)	720 x 576p (50 Hz) (4:3)	
	1280 x 720p (16:9)	720 x 480p (60 Hz) (4:3)	
	1280 x 720/50P (16:9)	1920 x 1080/50I (16:9)	
	1280 x 720/60P (16:9)	1920 x 1080/60I (16:9)	
Resolution of SD outputs for video (Composite) and S-Video (Y/C)	50Hz PAL 60Hz NTSC		
Dimensions and weights			
Weight	4.9 kg		
Dimensions (W x H x D)	300 x 120 x 416 mm		

ENDOCAM Performance HD

CCD camera head



1 ENDOCAM

- Universally applicable in all endoscopic disciplines thanks to very high sensitivity
- C-Mount connection: universal application – even for easy adaptation to OR microscopes
- Small, weight-reduced camera head with two function buttons
- Ergonomic, stress-free handling
- Remote control buttons to actuate peripheral devices such as printer for LED light source
- Accurate color rendering thanks to sophisticated color calibration
- Can be reprocessed by machine
- Suitable for low-temperature procedure

ENDOCAM Performance camera head **5514901**
50 Hz, cable length 4 m

ENDOCAM Performance camera head **5514961**
60 Hz, cable length 4 m

ENDOCAM Performance HD

Technical data of CCD camera head

Camera head		5514901 / 5514961
Device properties		
Sensor	1x 1/2" CCD	
Operation	2 head buttons with 4 functions	
Operating conditions	+10°C to +40°C, 30% to 75% rel. humidity, atmospheric pressure 700 hPa to 1060 hPa	
Equipment		
Thread for objective lens	C-Mount	
Degree of protection against the ingress of moisture	IPX7	
Dimensions and weight		
Camera head weight (without cable)	82 g	
Housing dimensions (W x H) - without cable and anti-kink protection	33 x 64 mm	
Camera head length (without cable)	111 mm	
Cable length	4 m	
Cable outlet	0°	

ENDOCAM Performance HD

System overview

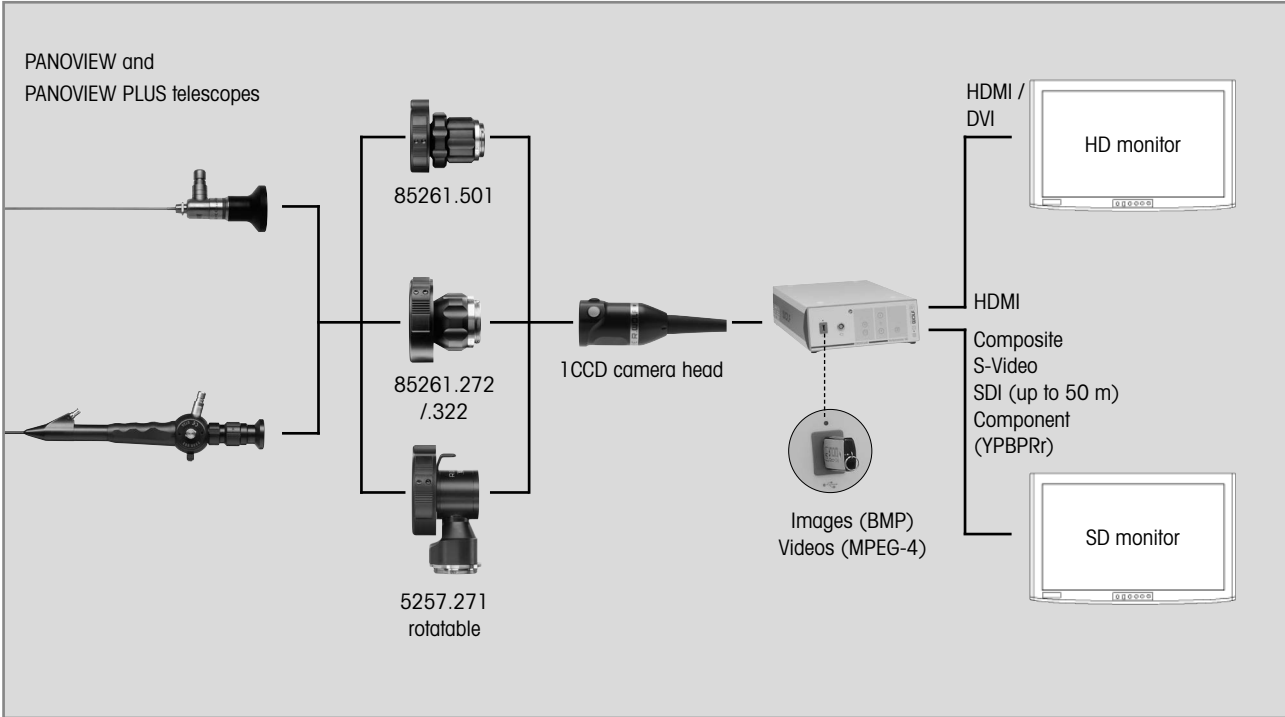

ENDOCAM Flex HD

Camera controller

ENDOCAM

1



- Small design – low space requirement
- Attractive price-performance ratio
- For universal use in urology and pneumology with the new, flexible sensor endoscopes
- Optional camera head when using rigid endoscopes
- Adaptation of various C-Mount lenses

- Integrated VESA 100 interface for mounting to the wall or on the side of a device cart
- Optional: Bracket for adaptation to a monitor
 - Please note the ordering details of the recommended mounting accessories
- Documentation on PC / laptop possible via ENDOCAM Flex documentation software

ENDOCAM Flex HD camera controller

bndl 555211011

Comprising:

1x ENDOCAM Flex HD camera controller 5521101
 1x HDMI/DVI-D cable, lockable, 3 m 103843
 1x power cable 2440.03

ENDOCAM Flex HD

Technical data of camera controller

Camera controller		5521101
Device properties		
Max. native video signal resolution	1920 x 1080 pixels	
White balance, color temperature range	2300 K to 7000 K	
Noise level	Noiseless, as no fan installed	
Digital zoom	1.5x max.	
Brightness control	Rolling shutter	
Operating conditions	+10°C to +40°C, 30% to 75% rel. humidity, atmospheric pressure 700 hPa to 1060 hPa	
Operating mode	Continuous operation	
Equipment		
IP rating	IP20	
Cooling method	Passive	
VESA mount	VESA 100 x 100 mm	
Power supply		
Mains + frequency	100-240 VAC, 50/60 Hz	
Power consumption	12 VA	
Current rating	0.1 - 0.05 A	
Regulatory standards		
Safety	US/ CA: UL 2601-1 / CSA C22.2 NO.601.1, EU: EN 60601	
EMC	EN 60601-1-2 / IEC 601-1-2	
Medical device class	Class 1	
Classification of applied part	BF	
Interfaces		
Video outputs	1x HDMI	
Resolution (HDMI output)	1920 x 1080 / 60p (16:9)	
USB port	USB 3.0	
Dimensions and weights		
Weight	1.5 kg	
Dimensions (W x H x D)	150 x 58 x 245 mm	

ENDOCAM Flex HD

Camera head

1 ENDOCAM



- Universally applicable in all endoscopic disciplines thanks to very high sensitivity
- C-Mount connection: universal application – even for easy adaptation to OR microscopes
- Small, weight-reduced camera head with two function buttons
- Ergonomic, stress-free handling
- Accurate color rendering thanks to sophisticated color calibration
- Can be reprocessed by machine
- Suitable for low-temperature procedure

ENDOCAM Flex HD camera head **5521902**

1-chip type, C-Mount, cable length 2.5 m

Recommended accessories	Product no.	
RIWO zoom lens	f = 13 - 29 mm	85261504
Angular lens	f = 17 mm	5257171

ENDOCAM Flex HD

Technical data of CCD camera head

Camera head		5521902
Device properties		
Sensor	1x 1/3" CMOS	
Operation	2 head buttons with preprogrammed functions	
Operating conditions	+10°C to +40°C, 30% to 75% rel. humidity, atmospheric pressure 700 hPa to 1060 hPa	
Equipment		
Thread for objective lens	C-Mount	
Degree of protection against the ingress of moisture	IPX7	
Service	Cable exchangeable	
Dimensions and weight		
Camera head weight (without cable)	125 g	
Housing dimensions (W x H) - without cable and anti-kink protection	34 x 34 mm	
Camera head length (without cable)	110 mm	
Cable length	2.5 m	
Cable outlet	30°	

ENDOCAM Flex HD

Compatible applied parts and camera head

ENDOCAM

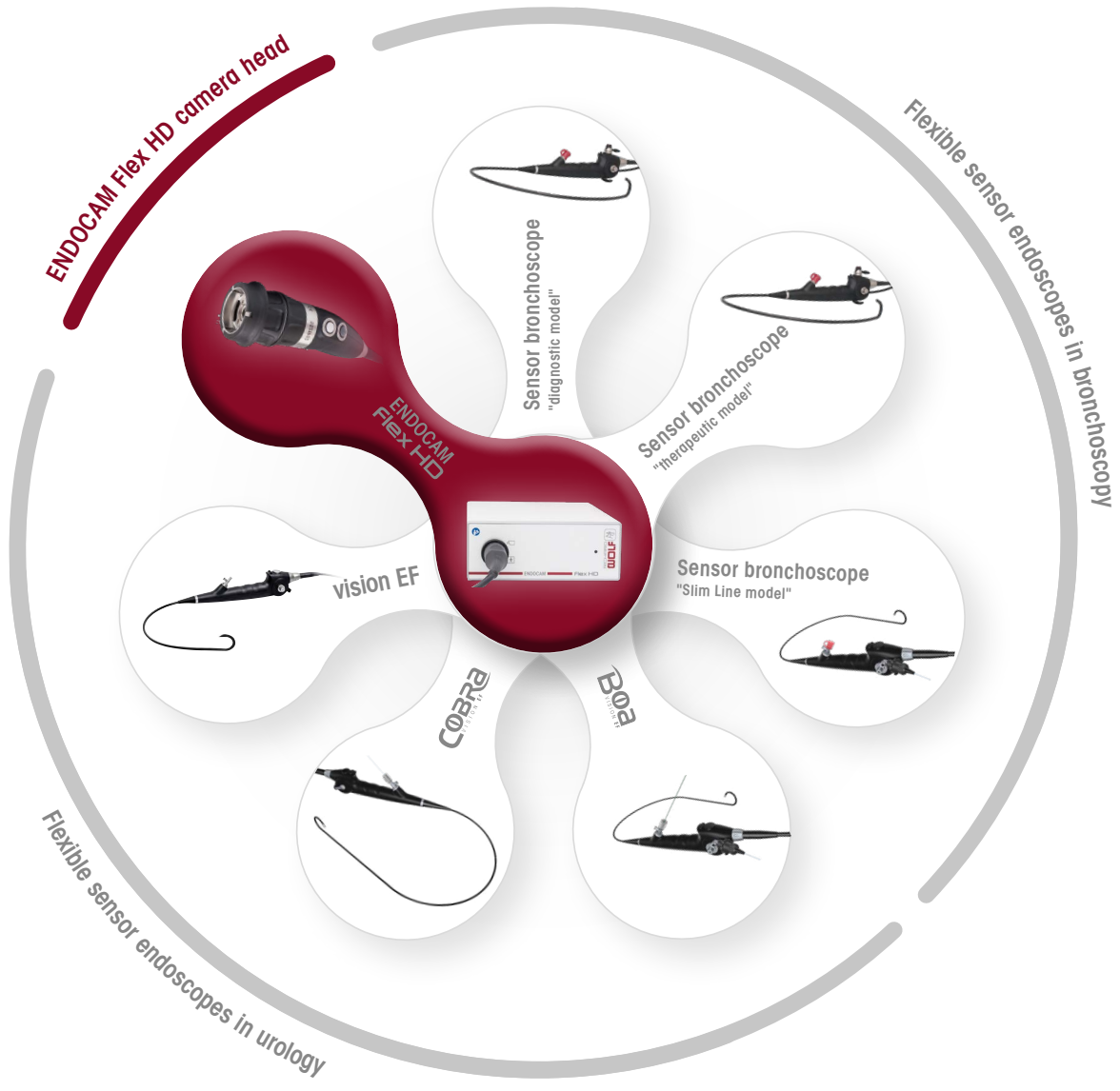

- ENDOCAM Flex HD camera head, 1-chip (5521902)
- Flexible sensor ureterorenoscope "COBRA Vision EF" (73561071/076)
- Flexible sensor ureterorenoscope "BOA Vision EF" (73551071/076)
- Flexible sensor cystoscope "Vision EF" (73151001/006)
- Flexible sensor bronchoscope "diagnostic model" (7250001)
- Flexible sensor bronchoscope "therapeutic model" (7260001)
- Flexible sensor bronchoscope "Slim Line model" (7236001)

V19 || Subject to modifications. Please note that some products may not be available in all countries. For more detailed information, please consult with your contact partner or directly with Richard Wolf GmbH.

Overview of mounting solutions

Mounting solutions		Product no.
	<p>VESA 100 console for 1 device</p> <p>For mounting the ENDOCAM Flex controller to a pedestal, VESA 100, Dimensions: (W x H x D) 84 x 157.5 x 220 mm</p>	<p>5370401</p>
	<p>VESA 100 console for 2 devices</p> <p>For mounting the ENDOCAM Flex controller and ENDOCAM Flex LED to a pedestal, VESA 100, Dimensions: (W x H x D) 114 x 308 x 220 mm</p>	<p>5370402</p>
	<p>Pedestal</p> <p>for combination with VESA 100 consoles</p>	<p>5370.0190</p>
	<p>Device mount VESA 100</p> <p>For mounting the ENDOCAM Flex controller and/or ENDOCAM Flex LED on the side of the RIWomobil or other vertical mounting surfaces, Dimensions: (W x H x D) 190 x 138 x 100 mm</p>	<p>32116452</p>

ENDOCAM Flex HD

Documentation software

ENDOCAM

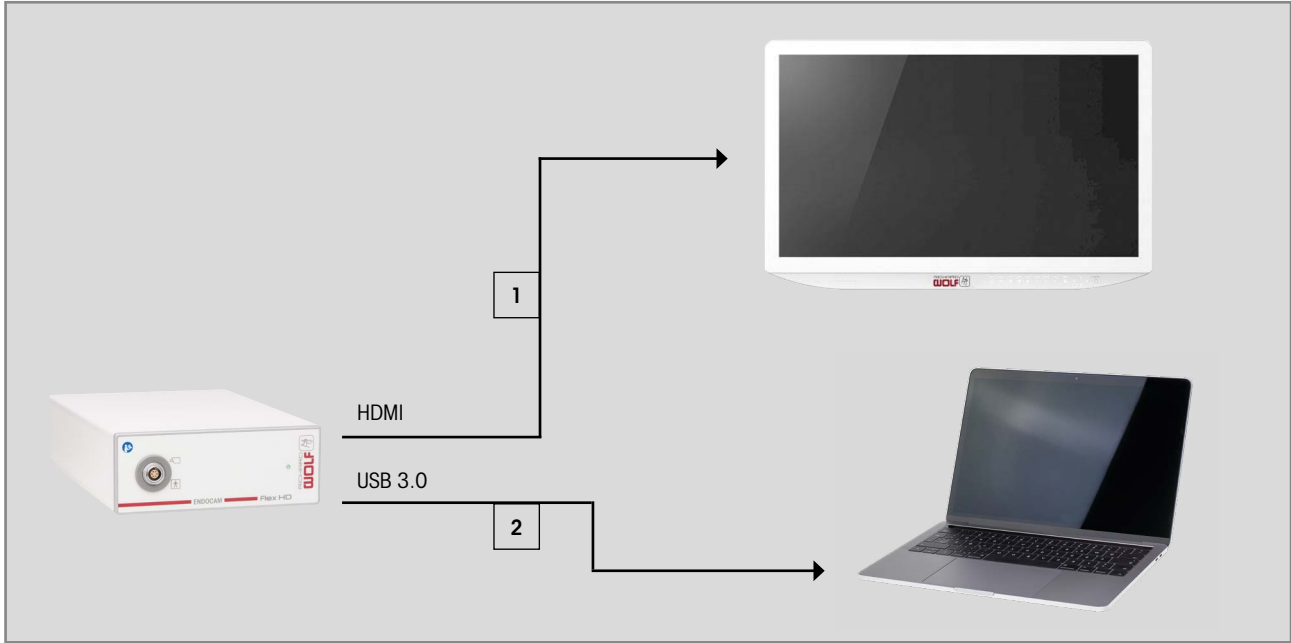

- Software for archiving data with the ENDOCAM Flex HD camera
 - Stores videos/images with patient information
 - Prints images
- Minimum hardware requirements:
Intel Core i5 - 2.4GHz CPU / 8GB RAM / USB-3 interface

- Recommended hardware requirements:
Intel Core i7 - 2.4GHz CPU / 8GB RAM / USB-3 interface
- The software supports the following operating systems:
Windows 7 / 8.1 / 10, 64-bit

Flex documentation software **5521201**
30-days demo version

Flex documentation software license **5521202**
for permanently using the Flex documentation software

Ultraflex USB 3.0 cable **4221-2.0M-UF**
USB cable, 3.0 compatible, high-speed capable,
USB type A to USB type B connector, length 2 m

ENDOCAM Flex HD

Overview

ENDOCAM Flex HD camera controller

bndl **55211011**

Comprising:

1x ENDOCAM Flex HD camera controller 5521101
 1x HDMI/DVI-D cable, lockable, 3 m 103843
 1x power cable 2440.03

ENDOCAM Flex HD camera head,

cable 2.5 m **5521902**

RIWO lenses, C-Mount

f = 14 mm **85261144**
 f = 24 mm **85261244**

Angular lenses, C-Mount

f = 14 mm **5257141**
 f = 24 mm **5257171**

RIWO zoom lens, C-Mount

f = 13 - 29 mm **5261504**

LIGHT SOURCE Flex LED bndl **51660011**

Comprising:

1x LIGHT SOURCE FLEX LED 42 W 5166001
 1x power cable 2440.03

Mounting solutions

VESA 100 console for 1 device 5370401
 VESA 100 console for 2 devices **5370402**
 Pedestal **53700190**
 Device mount VESA 100 **32116452**

Documentation

Flex documentation software **5521201**
 Flex documentation software license **5521202**
 Ultraflex USB 3.0 cable **4221-2.0M-UF**

HD LCD monitor

LCD MONITOR 21.5" **MDRAP21ELXACRW3**

Flexible applied parts for urology

Control lever in distal direction – articulation upward

Flexible sensor ureterorenoscope
 "BOA Vision EF" **735510761**
 "COBRA Vision EF" **735610761**
 Flexible sensor cystoscope "Vision EF" **731510061**

Control lever in distal direction – articulation downward

Flexible sensor ureterorenoscope
 "BOA Vision EF" **735510711**
 "COBRA Vision EF" **735610711**
 Flexible sensor cystoscope "Vision EF" **731510011**

Flexible applied parts for bronchoscopy

Flexible sensor bronchoscope "diagnostic model"
 Ø 5.2 mm, WL 600 mm **7250011**
 Flexible sensor bronchoscope "therapeutic model"
 Ø 6.2 mm, WL 600 mm **7260011**
 Flexible sensor bronchoscope "Slim Line model"
 Ø 2.9 mm, WL 680 mm **7236011**

ENDOCAM Epic 3DHD

Stereo camera controller incl. camera head

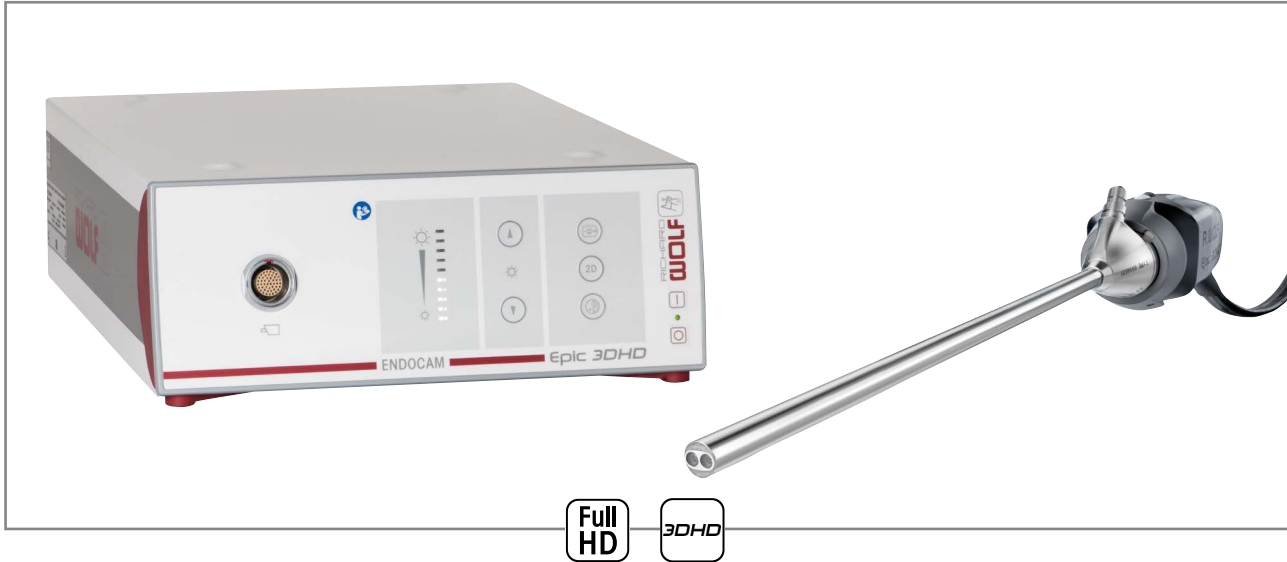

- Full HD dual 3-chip camera head for high-quality color rendering and HD image resolution
- Digital dual-link HD-SDI signal output for connecting professional 3DHD monitors
- Three dual-link signal outputs for flexible use with monitors, for 3D documentation or for video routing systems
- Digital signal processing
- Switching from 3D mode to 2D mode can be done directly on the controller
- Remote outputs for remote control (e.g. standby function of ENDOLIGHT light sources or controlling external color printers)
- Manual adjustment of measuring window to control imaging brightness
- White balance with memory function
- Automatic, electronic shutter control

ENDOCAM Epic 3DHD camera system

bndl **55310012**

Comprising:

- 1x ENDOCAM Epic 3DHD camera system 5531001
- 2x Coaxial cable vektor plus 2,00 m DZGR-0200-SW-GN
- 1x Power cable 2440.03

Recommended accessories	Product no.	
3D endoscope Ø 10 mm, WL 300 mm	0°	8934631
	30°	8934632
3D endoscope Ø 10 mm, WL 435 mm	0°	89344631
	30°	89344632
LCD monitor	LMD-3251MT	

ENDOCAM Epic 3DHD

System overview

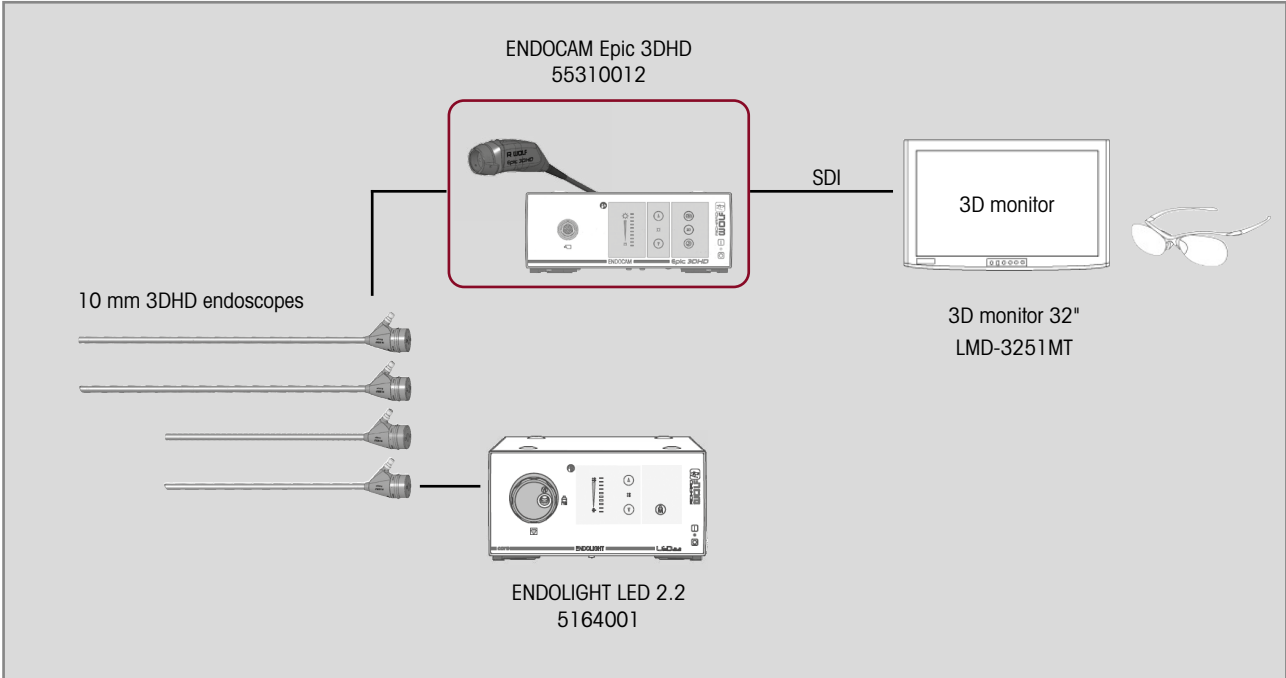

ENDOCAM Epic 3DHD

Technical data of camera controller

Camera controller		5531001
Device properties		
Type of controls	mech. buttons	
Max. video signal resolution	1920 x 1080 pixels	
White balance, color temperature range	2300 K to 7000 K	
Noise level	Noiseless, as no fan installed	
Brightness control	Automatic shutter control	
Operating conditions	+ 10°C to + 30°C , 30% to 75% rel. humidity, atmospheric pressure 700 hPa to 1060 hPa	
Operating mode	Continuous operation	
Equipment		
IP rating	IP20	
Cooling method	Passive	
Power supply		
Mains + frequency	100-240 VAC, 50/60 Hz	
Power consumption	40 VA	
Current rating	max. 0.6 A	
Regulatory standards		
Safety	US/ CA: UL 2601-1 / CSA C22.2 NO.601.1, EU: EN 60601	
EMC	EN 60601-1-2 / IEC 601-1-2	
Medical device class	Class 1	
Classification of applied part	CF	
Interfaces		
Video outputs	3x dual HD-SDI (6x BNC)	
Remote output	2 x 3.5 mm jack, stereo	
Resolution (HD-SDI output)	2x 1920 x 1080i (50Hz)	
Dimensions and weights		
Weight	6.8 kg	
Dimensions (W x H x D)	300 x 120 x 416 mm	

ENDOCAM Epic 3DHD

Technical data of CCD camera head

Camera head	
Device properties	
Operating conditions	+ 10°C to + 30°C , 30% to 75% rel. humidity, atmospheric pressure 700 hPa to 1060 hPa
Dimensions and weight	
Camera head weight (without cable)	390 g
Housing dimensions (W x H) - without cable and anti-kink protection	55 x 60 cm
length	140 mm
Length of camera cable	3.8 m
Cable outlet	30°

Accessories Signal cable





3G-SDI BNC cable				
	Vector Plus coax cable	1 m	DZGR-0100-SW-GN	
		2 m	DZGR-0200-SW-GN	
		3 m	DZGR-0300-SW-GN	
		15 m	DZGR-1500-SW-GN	
		25 m	DZGR-2500-SW-GN	
Accessories for cabling assembly				
	Vector Plus PUR coax cable	50 m	600-0211	
	BNC-HDTV rear twist		NBNC75BWU13	
	Crimp pliers For assembling BNC cables. Matching connector NBNC75BWU13		723231329	
	Crimp insert		723231330	
HDMI & DVI-D cable				
	DVI-D cable 18+1 (m) / 18+1 (m)	3 m	103.830	
	HDMI/DVI-D cable, lockable	3 m	103843	
	HDMI / HDMI cable lockable	3 m	103847	
	HDMI / HDMI cable	0.5 m	HDMI-MM-0.5MG-UF	

Accessories

Power cable - other cables

Power supply		Product no.		
		Adapter cable 12 VDC power supply for ENDOCAM Logic HD		103806
		Cable power supply CAN-BUS		643211527
Device connection cables				
		Device connection cable	0.6 m	32114.321
		Device connection cable	0.9 m	31100.922
		Device connection cable	3 m	32114.323
Potential equalization				
		POAG device cable Ø 4 mm	0.8 m	32114.311
		POAG supply line Ø 6 mm	6 m	32114.315
Interface cables				
		Remote control cable 3.5 mm / 3.5 mm (stereo)	1.5 m	5502.991
		Remote control cable 1x RS 232 to 9-pin DSUB plug, 2x 3.5 mm	2.0 m	5595.991
		Ultraflex USB 3.0 cable USB type A to USB type B connector	2.0 m	4221-2.0M-UF

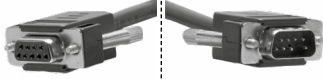
Accessories
Power cable - other cables

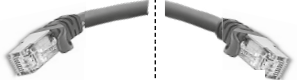
CAN bus				
	CAN bus connection cable 2x SUB-D 9-pin (m)	0.4 m	103.701	
	CAN bus terminator		5590.989	
Serial data cable				
	ST/BU 9-pin D-SUB	10 m	72325.361	
	ST/BU 9-pin D-SUB	1 m	72325380	
Ethernet cable				
	Patch cable, RJ45 SFTP	0.5 m	72325378	
	Patch cable, RJ45 HRS TM11	1 m	72325429	
	Ethernet cable, RJ45 S/FTP CAT.6	2 m	103.03	
	Ethernet cable	5 m	72325.328	
	Patch cable, RJ45 S/FTP CAT.6	10 m	72325434	
	Patch cable, RJ45 S/FTP CAT.6	20 m	72325435	
	Shielded twisted-pair cable	0.9 m	XTP DTP 24/3	
		7.6 m	XTP DTP 24/25	
		22.4	XTP DTP 24/75	
		30.4	XTP DTP 24/100	

Accessories

Keyboards - storage media

Keyboards	Product no.	
	Mini CleanBoard USB German version (QWERTZ)	103823
	Mini CleanBoard USB US / English version (QWERTY)	103824

■ **Keyboards**

Wipe-clean USB keyboard incl. mouse pad. Magnets integrated on the underside for reliable surface contact. IP65 splash-water protected, suitable for common disinfectants.
 Dimensions (W x H x D): 300 x 22.4 x 180 mm

USB flash memory	Product no.	
	USB flash memory 8 GB Formatting: FAT32	56540028
	USB flash memory 32 GB	72321829

RIWO lenses

RIWO zoom lens with snap-on mechanism and C-Mount thread, steam-sterilizable and reprocessable by machine		Product no.
 <p>AUTOCLAVE 134° C / 273° F</p>	<p>RIWO zoom lens f = 21 - 36 mm</p>	<p>85261.501</p>
RIWO zoom lens with snap-on mechanism and C-Mount thread, steam-sterilizable and reprocessable by machine		
 <p>AUTOCLAVE 134° C / 273° F</p>	<p>RIWO zoom lens f = 13 - 29 mm</p>	<p>85261504</p>
RIWO zoom lens with snap-on mechanism and C-Mount thread, reprocessable by machine and suitable for low-temperature procedure		
	<p>RIWO zoom lens f = 13 - 29 mm</p>	<p>5261504</p>
RIWO lens with snap-on mechanism and C-Mount thread, steam-sterilizable and reprocessable by machine		
 <p>AUTOCLAVE 134° C / 273° F</p>	<p>RIWO lens f = 14 mm</p>	<p>85261144</p>
	<p>RIWO lens f = 24 mm</p>	<p>85261244</p>
RIWO lens with snap-on mechanism and C-Mount thread, steam-sterilizable and reprocessable by machine		
 <p>AUTOCLAVE 134° C / 273° F</p>	<p>RIWO lens f = 27 mm</p>	<p>85261.272</p>
	<p>RIWO lens f = 32 mm</p>	<p>85261.322</p>

RIWO lenses / adapters

RIWO angular lens with rotatable snap-on mechanism and C-Mount thread, suitable for reprocessing by machine and low-temperature procedure

Product no.



RIWO angular lens
Beam divider 10% eye, 90% camera,

f = 24 mm

5257.271

RIWO angular lens with rotatable snap-on mechanism and C-Mount thread and suspension function, suitable for reprocessing by machine and low-temperature procedure

f = 14 mm for ENDOCAM 5525
f = 17 mm for ENDOCAM 5521



RIWO angular lens
f = 14 mm, image format 16:9 / 16:10

5257141

RIWO angular lens
f = 17 mm, image format 4:3 / 5:4

5257171

Connection of C-Mount lenses to endoscopes (telescopes) with plug-on connection



Sterile adapter

8580.91



Plug-on eyecup

8885.901

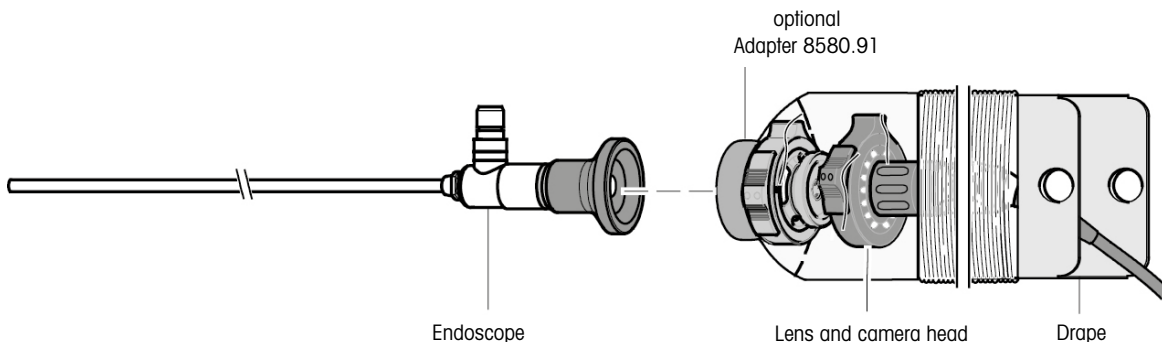

Medical LCD monitor 4K 55"



- OptiContrast Panel™ (IPS) with 520 cd/m² and 1400:1 contrast
- Slim housing with narrow edge for optimum use of screen surface
- Outstanding image quality even when displaying zoomed images
- Optimized presets for Richard Wolf

LCD monitor 4K 55" **LMD-X550NB**

Accessories		Product no.
Monitor cart (trolley)		32116000
Monitor mounting bracket VESA 200 x 400		32116472
Balancing module for RIWomobil without electrical equipment		32116458
Balancing module for RIWomobil with baseline electrics		32116459
RIWomobil device cart		
RIWomobil device cart with baseline electrics and reinforced bridge	100-120 VAC	32116012
	220-240 VAC	32116014
RIWomobil device cart with premium-line electrics and reinforced bridge	100-120 VAC	32116013
	220-230 VAC	32116015
Protective cover		
Protective cover for 55" monitor		53700055

LCD monitor 4K 55"

Technical data

LCD monitor 4K 55"		LMD-X550NB	
Device properties			
Screen diagonal	55"		
Resolution / aspect ratio	3840 x 2160 pixels / 16:9		
Background lighting	LED		
Panel technology	IPS		
Display colors	1,073,000,000		
Contrast	1400 : 1		
Max. luminance	620 cd/m ²		
Response time	20 ms		
Angle of view	178° H / 178° V		
Equipment			
Video input / output	4K in: 1x HDMI or 4x BNC (3G-SDI) out: 4x BNC	HD: in: 5x BNC (3G-/HD-/SD-SDI), 1x DVI-D out: 5x BNC (3G-/HD-/SD-SDI), 1x DVI-D	
VESA mount	VESA 200 x 200 VESA 300 x 300		
IP rating	IPX2		
Power supply			
Mains + frequency	100 - 240 VAC, 50/60 Hz		
Power consumption	290 VA		
Current rating	2.1 - 1.0 A		
Power supply	Internal power supply unit		
Regulatory standards			
Safety	US/CA: UL 60601-1, CAN/CSA-C22.2 No. 60601-1, EU: EN 60601-1		
EMC	US/CA: FCC Part 15 Class A, ICES-003 Class A, EU: EN 60601-1-2, AU: EN 55011 Class B, J: VCCA Class A"		
CB certification	IEC 60601-1, IEC 60065		
Medical device class	MDD (EU): Class I Medical Device FD&C Act FDA: Class II Medical Device		
Dimensions and weight			
Weight	35.2 kg		
Dimensions (W x H x D)	1264.6 x 771.5 x 85.5 mm		

Medical LCD monitor 4K 31"



- a-Si TFT Active Matrix LCD
- Very bright OptiContrast Panel™ (IPS) with 770 cd/m² and 1450:1 contrast
- Slim housing with narrow edge for optimum use of screen surface
- Outstanding image quality even when displaying zoomed images
- Optimized presets for Richard Wolf
- External power supply unit

LCD monitor 4K 31" LMD-X310NB

Recommended accessories		Product no.
FLEXION-PORT 400 (68 cm) bndl	Swivel arm Mounting on the side in the aluminum profile	321160681
FLEXION-PORT 350+300 (93 cm) bndl		321160931
FLEXION-PORT 400 (68 cm) bndl	Swivel arm Mounting on the reinforced monitor bridge	321160682
FLEXION-PORT 350+300 (93 cm) bndl		321160932
Monitor mounting bracket VESA 75 x 100		321165001
Monitor stand		SU-600MD
External power supply unit AC adapter for LCD monitor 4K 31"		AC-300MD
For extending the power supply unit on the secondary end		
Vector Plus PUR coax cable (50 m)		600-0211
Neutrik XLR 3-pin socket		NC3FXX
Neutrik XLR 3-pin plug		NC3MXX
Protective cover		
Protective cover for 31" monitor		53700031

LCD monitor 4K 31"

Technical data

LCD monitor 4K 31"		LMD-X310NB	
Device properties			
Screen diagonal	31"		
Resolution / aspect ratio	4096 x 2160 pixels / 17:9		
Background lighting	LED		
Panel technology	IPS		
Display colors	1,073,000,000		
Contrast	1450:1		
Max. luminance	770 cd/m ²		
Response time	20 ms		
Angle of view	178° H / 178° V		
Equipment			
Video input / output	4K in: 1x HDMI or 4x BNC (3G-SDI) out: 4x BNC	HD: in: 5x BNC (3G-/HD-/SD-SDI), 1x DVI-D out: 5x BNC (3G-/HD-/SD-SDI), 1x DVI-D	
VESA mount	VESA 100 x 100 VESA 200 x 200		
IP rating	IPX2		
Power supply			
Mains + frequency	100 - 240 VAC, 50/60 Hz		
Power consumption	180 VA		
Current rating	2.1 - 1.0 A		
Power supply	External power supply unit		
Regulatory standards			
Safety	US/CA: UL 60601-1, CAN/CSA-C22.2 No. 60601-1, EU: EN 60601-1		
EMC	US/CA: FCC Part 15 Class A, ICES-003 Class A, EU: EN 60601-1-2, AU: EN 55011 Class B, J: VCCA Class A"		
CB certification	IEC 60601-1, IEC 60065		
Medical device class	MDD (EU): Class I Medical Device FD&C Act FDA: Class II Medical Device		
Dimensions and weight			
Weight	11.8 kg		
Dimensions (W x H x D)	754 x 456 x 69 mm		
External power supply unit weight	1.5 kg		
External power supply unit dimensions (W x H x D)	245 x 150 x 58 mm / cable length between monitor and power supply unit: 2.8 m		

Medical LCD monitor 27" 4K



- Very bright panel with 800 cd/m² and 1000:1 contrast
- 4K resolution with 3840 x 2160 pixels
- Slim housing with narrow edge for optimum use of the display
- Direct power supply or optionally via an external power supply unit
- Optimized color matching for Richard Wolf ENDOCAM
- Automatic switching to second monitor input if the connection to input 1 is interrupted

LCD monitor 27" 4K LMD-X2705N

Recommended accessories		Product no.
FLEXION-PORT 300 (58 cm) bndl	Swivel arm Mounting on the side in the aluminum profile	321160581
FLEXION-PORT 350+400 (103 cm) bndl		321161031
FLEXION-PORT 400 (68 cm) bndl		321160681
FLEXION-PORT 350+300 (93 cm) bndl		321160931
FLEXION-PORT 300 (58 cm) bndl	Swivel arm Mounting on the reinforced monitor bridge	321160582
FLEXION-PORT 350+400 (103 cm) bndl		321161032
FLEXION-PORT 400 (68 cm) bndl		321160682
FLEXION-PORT 350+300 (93 cm) bndl		321160932
Monitor mount VESA 75/100		321165001
Monitor stand		SU-600MD
External power supply unit AC adapter for LCD monitor 4K 31"		AC-300MD
For extending the power supply unit on the secondary end		
Vector Plus PUR coax cable 50,00m PUR		600-0211
Neutrik XLR 3 pole female cable connector		NC3FFX
Neutrik XLR 3 pole male cable connector		NC3MXX
Protective cover		
Protective cover for monitor 27"		53700027

LCD monitor 27" 4K

Technical data

LCD monitor 27" 4K		LMD-X2705N
Device properties		
Screen diagonal	27"	
Resolution / aspect ratio	3840 x 2160 / 16:9	
Background lighting	LED	
Display colors	1.073.000.000	
Contrast	1000:1	
Max. luminance	800 cd/m ²	
Response time	4 ms	
Angle of view	178° H / 178° V	
Equipment		
Video input / output (SD)	In: 1x HDMI 2.0b, 1x DVI-D, 1x 3G/HD/SD-SDI, 2x display port Out: 1x DVI-D, 1x 3G/HD/SD-SDI, 1x display port	
VESA mount	VESA 100 x 100	
IP rating	IPX5 (front), IPX2 (all other sides)	
Power supply		
Mains + frequency	100 - 240 VAC, 50/60 Hz	
Power consumption	149 VA	
Current rating	1.5 to 0.7 A	
Power supply unit	Internal power supply unit	
Regulatory standards		
Safety	US: UL (ANSI_AAMI ES60601-1, FCC (Class A Digital Device) Canada: cUL (Can/CSA-C22.2 (No. 60601-1)), ISED (ISED Class A Digital Device) EU: CE (MDD) (EN 60601-1 + EN60601-1-2)	
CB certification	IEC60065, IEC 62368-1, IEC60601-1	
Medical device class	MDD (EU): Class I Medical Device; FD&C Act FDA: Class II Medical Device	
Dimensions and weight		
Weight	8.8 kg	
Dimensions (W x H x D)	658.8 x 426.8 x 80 mm	

Medical LCD monitor 21.5"



- HDTV-capable compact widescreen LCD with 21.5" screen diagonal
- Preferably used as a second observation monitor or in combination with ENDOCAM Performance HD / ENDOCAM Flex HD
- Excellent color rendering
- VESA mount for ergonomic fastening to swivel arms

LCD monitor 21.5" **MDRAP21ELXACRW3**

Recommended accessories	Product no.
Pedestal	OP-MED-TF-R9016

LCD monitor 21.5"

Technical data

LCD monitor 21.5"		MDRAP21ELXACRW3
Device properties		
Screen diagonal	21.5"	
Resolution / aspect ratio	1920 x 1080 pixels / 16:9	
Background lighting	LED	
Display colors	16,700,000	
Contrast	1000:1	
Max. luminance	250 cd/m ²	
Response time	14 ms	
Angle of view	178° H / 178° V	
Equipment		
Video input / output (SD)	in: 1x DVI-I, 1x VGA, 1x display port	
Signal inputs	1x VGA (HD 15)	
VESA mount	VESA 100 x 100	
IP rating	IPX1	
Power supply		
Mains + frequency	100 - 250 VAC, 50/60 Hz	
Power consumption	85 VA	
Power supply	External power supply unit	
Regulatory standards		
Safety	EU: EN 60601-1	
Medical device class	MDD (EU): Class I Medical Device	
Dimensions and weight		
Weight	5.7 kg	
Dimensions (W x H x D)	537 x 384 x 236 mm	

ENDOLIGHT LED 2.2

LED light source



51 Light sources

- The light output is comparable to a 300-watt xenon illuminant
- The LED service life is at least 30,000 hours
- The LED light source reduces power consumption by up to 80% compared to an equivalent xenon light source
- Extremely quiet heatpipe ventilation concept at only 25 dB(A) noise level
- Light cables from different manufacturers (Richard Wolf, Storz, Olympus, ACMI) can directly be connected to the multi-port socket

- Automatic dimming of the light cable socket if the light cable is removed
- Very homogenous illumination of the endoscopic surgical area. No drop in brightness in the peripheral area and no "black spot" in the center
- Very stable color temperature (6500 Kelvin) over the entire LED service life
- Dialog function in conjunction with ENDOCAM Logic camera systems
- Compatible with core nova

Light source ENDOLIGHT LED 2.2 bndl 51640011

Comprising:

1x ENDOLIGHT LED 2.2	5164001
1x patch cable, RJ45 SFTP, 0.5 m	72325378
1x power cable	2440.03

ENDOLIGHT LED 2.2

Technical data

ENDOLIGHT LED 2.2		5164001
Device properties		
Type and number of lamps	1x high-power LED	
Lamp service life	30,000 h	
Brightness in Lumen	1900 lm	
Light output compared to xenon in W	300 W	
Color temperature	6500 K	
Brightness control	0 - 100%	
Noise level	25 dB(A)	
Operating mode	Continuous operation	
Operating conditions	+10°C to +40°C, 30% to 75% rel. humidity, atmospheric pressure 700 hPa to 1060 hPa	
Equipment		
Supported light cables	Wolf, Storz, Olympus, ACMI	
IP rating	IP20	
Cooling method	Passive heatpipe, fan	
Power supply		
Mains + frequency	100-240 VAC, 50/60 Hz	
Power consumption	150 VA	
Current rating	1.1-0.6 A	
Regulatory standards		
Safety	EU: EN 60601-1	
EMC	EN 60601-1-2 / IEC 601-1-2	
Medical device class	Class 1	
Classification	CF	
Dimensions and weight		
Weight	10.5 kg	
Dimensions (W x H x D)	300 x 160 x 421 mm	

ENDOLIGHT LED_{2.1}

LED light source



51 Light sources

- The light output is comparable to a 300-watt xenon illuminant
- The LED service life is at least 30,000 hours
- The LED light source reduces power consumption by up to 80% compared to an equivalent xenon light source
- Extremely quiet heatpipe ventilation concept at only 25 dB(A) noise level
- Automatic dimming of the light cable socket if the light cable is removed
- Very homogenous illumination of the endoscopic surgical area. No drop in brightness in the peripheral area and no "black spot" in the center
- Very stable color temperature (6500 Kelvin) over the entire LED service life

Light source ENDOLIGHT LED 2.1

bndl **51630011**

Comprising:

1x ENDOLIGHT LED 2.1 5163001
 1x power cable 2440.03

ENDOLIGHT LED 2.1

Technical data

ENDOLIGHT LED 2.1		5163001
Device properties		
Type and number of lamps	1x high-power LED	
Lamp service life	30,000 h	
Brightness in Lumen	1900 lm	
Light output compared to xenon in W	300 W	
Color temperature	6500 K	
Brightness control	0 - 100%	
Noise level	25 dB(A)	
Operating mode	Continuous operation	
Operating conditions	+10°C to +40°C, 30% to 75% rel. humidity, atmospheric pressure 700 hPa to 1060 hPa	
Equipment		
Supported light cables	Wolf	
IP rating	IP20	
Cooling method	Passive heatpipe, fan	
Power supply		
Mains + frequency	100-240 VAC, 50/60 Hz	
Power consumption	150 VA	
Current rating	1.1-0.6 A	
Regulatory standards		
Safety	EU: EN 60601-1	
EMC	EN 60601-1-2 / IEC 601-1-2	
Medical device class	Class 1	
Classification	CF	
Dimensions and weight		
Weight	9.6 kg	
Dimensions (W x H x D)	300 x 160 x 421 mm	

System green
ENDOLIGHT LEDgreen
LED light source



- LED light source for the endoscopic NIR/ICG application
- Switchable between NIR/ICG and white light endoscopy
- Powerful NIR/ICG illumination
- The light output is comparable to a 300W xenon light source
- Guaranteed LED lamp service life in white light mode 15000h
- Compatible with core nova
- Automatic exposure control and adjustment of light intensity in conjunction with ENDOCAM Logic 4K/HD (dialog functionality) for optimal illumination
- Light output for rigid and flexible endoscopes

Light source LEDgreen bndl 51650021

Comprising:

- 1x light source LEDgreen 5165002
- 1x patch cable, RJ45 SFTP, 0.5 m 72325378
- 1x power cable 2440.03

Optional accessories:			
Foot control rockerswitch			2030.105
<i>fusion</i> Fiber light cable bndl comprising: Fiber light cable, Adapter, projector side (8095.07), and adapter, endoscope side (809509)	Ø of fiber bundle 5.0 mm and color code grey	2.3 m long	806550231
		3.0 m long	806550301
		3.5 m long	806550351

System green

ENDOLIGHT LED_{green}

Technical data

ENDOLIGHT LEDgreen		5165002
Device properties		
Type and number of lamps	2x high-power LED	
Lamp service life	15,000 h	
Brightness in Lumen	1,400 lm	
Light output compared to xenon in W	300 W	
Color temperature	8000 K	
Brightness control	0 - 100%	
Noise level	30 dB(A)	
Operating mode	Continuous operation	
Operating conditions	+10°C to +40°C, 20% to 75% rel. humidity, atmospheric pressure 700 hPa to 1060 hPa	
Equipment		
Supported light cables	Wolf	
IP rating	IP20	
Cooling method	Passive heatpipe	
Power supply		
Mains + frequency	100-240 VAC, 50/60 Hz	
Power consumption	225 VA	
Current rating	1.5-0.6 A	
Regulatory standards		
Safety	EU: EN 60601-1	
EMC	EN 60601-1-2 / IEC 601-1-2	
Medical device class	Class 1	
Classification	CF	
Dimensions and weight		
Weight	10.3 kg	
Dimensions (W x H x D)	300 x 160 x 424 mm	

System blue

ENDOLIGHT LED_{blue}

LED light source



- LED light source for use in photodynamic diagnostics (PDD)
- Switchable between blue light and white light mode
- The light output is comparable to a 180-watt xenon illuminant
- The LED service life is at least 30,000 hours
- The LED light source reduces power consumption by up to 80% compared to an equivalent xenon light source
- Extremely quiet heatpipe ventilation concept at only 25 dB(A) noise level

- Automatic dimming of the light cable socket if the light cable is removed
- Very homogenous illumination of the endoscopic surgical area. No drop in brightness in the peripheral area and no "black spot" in the center
- Very stable color temperature (6500 Kelvin) over the entire LED service life
- Dialog function in conjunction with ENDOCAM Logic camera-systems
- Compatible with **core nova**

Light source ENDOLIGHT LED blue bndl 51650011

Comprising:

1x ENDOLIGHT LED blue	5165001
1x patch cable, RJ45 SFTP, 0.5 m	72325378
1x toggle switch	2030.105
1x power cable	2440.03

System blue

ENDOLIGHT LED_{blue}

Technical data

ENDOLIGHT LED blue		5165001
Device properties		
Type and number of lamps	2x high-power LED	
Lamp service life	30,000 h	
Brightness in Lumen	1,100 lm	
Light output compared to xenon in W	180 W	
Color temperature	6500 K	
Brightness control	0 - 100%	
Noise level	25 dB(A)	
Operating mode	Continuous operation	
Operating conditions	+10°C to +40°C, 30% to 75% rel. humidity, atmospheric pressure 700 hPa to 1060 hPa	
Equipment		
Supported light cables	Wolf	
IP rating	IP20	
Cooling method	Fan	
Power supply		
Mains + frequency	100-240 VAC, 50/60 Hz	
Power consumption	192 VA	
Current rating	1.6-0.8 A	
Regulatory standards		
Safety	EU: EN 60601-1	
EMC	EN 60601-1-2 / IEC 601-1-2	
Medical device class	Class 1	
Classification	CF	
Dimensions and weight		
Weight	10.5 kg	
Dimensions (W x H x D)	300 x 160 x 421 mm	

ENDOLIGHT LED 1.2

LED light source



- The light output is comparable to a 180-watt xenon illuminant
- The LED service life is at least 30,000 hours
- The LED light source reduces power consumption by up to 80% compared to an equivalent xenon light source
- Extremely quiet ventilation concept at only 25 dB(A) noise level
- Light cables from different manufacturers (Richard Wolf, Storz, Olympus, ACMI) can directly be connected to the multi-port socket
- Automatic dimming of the light cable socket if the light cable is removed
- Very homogenous illumination of the endoscopic surgical area. No drop in brightness in the peripheral area and no "black spot" in the center
- Very stable color temperature (6500 Kelvin) over the entire LED service life
- The key brightness is automatically adjusted to the ambient light and so legibility is always good, without any glare

Light source ENDOLIGHT LED 1.2

bndl **51610011**

Comprising:

1x ENDOLIGHT LED 1.2 5161001
1x power cable 2440.03

ENDOLIGHT LED 1.2

Technical data

ENDOLIGHT LED 1.2		5161001
Device properties		
Type and number of lamps	1x high-power LED	
Lamp service life	30,000 h	
Brightness in Lumen	1000 lm	
Light output compared to xenon in W	180 W	
Color temperature	6500 K	
Brightness control	0 - 100%	
Noise level	25 dB(A)	
Operating mode	Continuous operation	
Operating conditions	+10°C to +40°C, 30% to 75% rel. humidity, atmospheric pressure 700 hPa to 1060 hPa	
Equipment		
Supported light cables	Wolf, Storz, Olympus, ACMI	
IP rating	IP 20	
Cooling method	Fan	
Power supply		
Mains + frequency	100-240 VAC, 50/60 Hz	
Power consumption	120 VA	
Current rating	1.1-0.5 A	
Regulatory standards		
Safety	EU: EN 60601-1	
EMC	EN 60601-1-2 / IEC 601-1-2	
Medical device class	Class 1	
Classification	CF	
Dimensions and weight		
Weight	8.9 kg	
Dimensions (W x H x D)	300 x 120 x 424 mm	

ENDOLIGHT LED 1.1

LED light source



51 Light sources

- The light output is comparable to a 180-watt xenon illuminant
- The LED service life is at least 30,000 hours
- The LED light source reduces power consumption by up to 80% compared to an equivalent xenon light source.
- Extremely quiet ventilation concept at only 25 dB(A) noise level
- Connection option for Richard Wolf light cable
- Automatic dimming of the light cable socket if the light cable is removed
- Very homogenous illumination of the endoscopic surgical area. No drop in brightness in the peripheral area and no "black spot" in the center
- Very stable color temperature (6500 Kelvin) over the entire LED service life
- Very good price-performance ratio

Light source ENDOLIGHT LED 1.1

bndl **51600011**

Comprising:

1x ENDOLIGHT LED 1.1 5160001
 1x power cable 2440.03

ENDOLIGHT LED II

Technical data

ENDOLIGHT LED 1.1		5160001
Device properties		
Type and number of lamps	1x high-power LED	
Lamp service life	30,000 h	
Brightness in Lumen	1000 lm	
Light output compared to xenon in W	180 W	
Color temperature	6500 K	
Brightness control	0 - 100%	
Noise level	25 dB(A)	
Operating mode	Continuous operation	
Operating conditions	+10°C to +40°C, 30% to 75% rel. humidity, atmospheric pressure 700 hPa to 1060 hPa	
Equipment		
Supported light cables	Wolf	
IP rating	IP 20	
Cooling method	Fan	
Power supply		
Mains + frequency	100-240 VAC, 50/60 Hz	
Power consumption	120 VA	
Current rating	1.1 - 0.5 A	
Regulatory standards		
Safety	EU: EN 60601-1	
EMC	EN 60601-1-2 / IEC 601-1-2	
Medical device class	Class 1	
Classification	CF	
Dimensions and weight		
Weight	8.5 kg	
Dimensions (W x H x D)	300 x 120 x 421 mm	

ENDOLIGHT Flex LED

LED light source



5 Light sources

- Extremely compact design
- The light output is comparable to a 180-watt xenon illuminant
- The LED illuminant exhibits only minimal power loss over the entire service life
- The LED service life is at least 30,000 hours
- The LED light source reduces power consumption by up to 80% compared to an equivalent xenon light source
- Extremely quiet ventilation concept at only 30 dB(A) noise level
- Connection option for Richard Wolf light cable
- Automatic dimming of the light cable socket if the light cable is removed
- Very homogenous illumination of the endoscopic surgical area. No drop in brightness in the peripheral area and no "black spot" in the center
- Very stable color temperature (6500 Kelvin) over the entire LED service life
- Very good price-performance ratio
- VESA 100 mount on the underside - versatile mounting options

Light source ENDOLIGHT Flex LED bndl 51660011

Comprising:

- 1x ENDOLIGHT Flex LED 5166001
- 1x power cable 2440.03

Recommended accessories		Product no.
Device mount VESA 100	For mounting a "Flex" series device on the side of the RIWomobil or on other vertical mounting surfaces Dimensions (W x H x D): 190 x 138 x 100 mm	32116452

ENDOLIGHT Flex LED

Technical data

ENDOLIGHT Flex LED		5166001
Device properties		
Type and number of lamps	1x high-power LED	
Lamp service life	30,000 h	
Brightness in Lumen	1350 lm	
Light output compared to xenon in W	180 W	
Color temperature	6500 K	
Brightness control	0 - 100%	
Noise level	30 dB(A)	
Operating mode	Continuous operation	
Operating conditions	+10°C to +40°C, 30% to 75% rel. humidity, atmospheric pressure 700 hPa to 1060 hPa	
Equipment		
Supported light cables	Wolf	
IP rating	IP 20	
Cooling method	Fan	
Power supply		
Mains + frequency	100-240 VAC, 50/60 Hz	
Power consumption	110 VA - 145 VA	
Current rating	1.1-0.6 A	
Regulatory standards		
Safety	EU: EN 60601-1	
EMC	EN 60601-1-2 / IEC 601-1-2	
Medical device class	Class 1	
Classification	BF	
Dimensions and weight		
Weight	1.8 kg	
Dimensions (W x H x D)	150 x 58 x 245 mm	

fusion

Fiber light cable

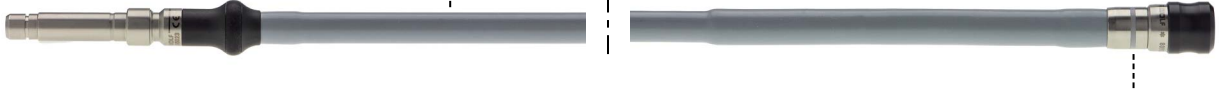

fusion

Anti-kink protection under the sheath for optimum hygiene properties

"Snap" quick release coupling

The color ring **system** for the handle at the endoscope side allows you to easily and quickly assign the matching light cable to the endoscope in use.

Standard
Light cables with adhesive

fusion
High-temperature-resistant light cables

Ø 5.0 mm gray

Innovative color coding system

- Improved light transmission thanks to a special design
- High-performance fiber optic material "made in Germany"
- Fast "snap-on" precision connection between endoscope and light cable
- Anti-kink protection made of steel allows for a particularly high number of usage cycles
- Suitable for low-temperature procedure
- Steam-sterilizable
- Adapters for compatibility with light sources and endoscopes from different manufacturers
- Standardized color coding of light cables and endoscopes based on their diameters



fusion

Fiber light cable are exclusively available with 5.0 mm fiber diameter

Fusion

Fiber light cable

Fusion Fiber light cable, complete	Color coding on endoscope side	Ø of fiber bundle and color code	Length	Fiber light cable without adapter Product no.	Complete Product no.
 <p>Fiber light cable, bndl Comprising: Fiber light cable, Adapter, projector side (8095.07), and adapter, endos- cope side (809509)</p>		5.0 mm gray	2.3 m	80655023*	806550231
			3.0 m	80655030*	806550301
			3.5 m	80655035*	806550351

* The *Fusion* light cables can also be ordered without adapter. Adapters for connecting products from other manufacturers are offered as separate items in our product range.

Fiber light cable

Anti-kink protection under the sheath for optimum hygiene properties

"Snap-on" quick release coupling

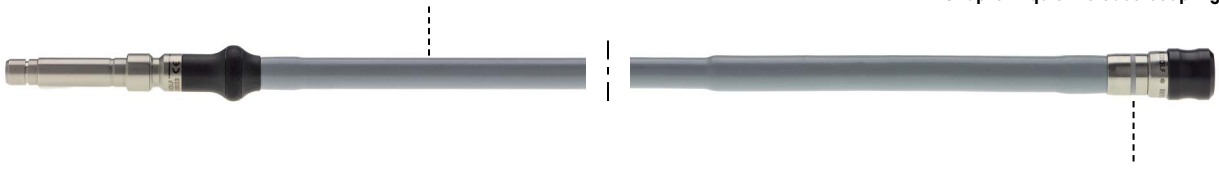

The color ring system for the handle at the endoscope side allows you to easily and quickly assign the matching light cable to the endoscope in use.





∅ 1.6 mm	blue
∅ 2.5 mm	green
∅ 3.5 mm	orange
∅ 5.0 mm	gray

Innovative color coding system

- High-performance fiber optic material "made in Germany"
- Fast "snap-on" precision connection between endoscope and light cable
- Anti-kink protection made of steel allows for a particularly high number of usage cycles
- Suitable for low-temperature procedure
- Steam-sterilizable
- Standardized color coding of light cables and endoscopes based on their diameters
- Adapters for compatibility with light sources and endoscopes from different manufacturers



Fiber light cable with color coding

Fiber light cable, complete	Color coding on endoscope side	Ø of fiber bundle and color code	Length	Fiber light cable without adapter Product no.	Complete Product no.
 <p>Fiber light cable, bndl Comprising: Fiber light cable, Adapter, projector side (8095.07), and adapter, endoscope side (809509)</p>		1.6 mm blue	1.8 m	80661618*	806616181
			2.3 m	80661623*	806616231
			3.0 m	80661630*	806616301
		2.5 mm green	1.8 m	80662518*	806625181
			2.3 m	80662523*	806625231
			3.0 m	80662530*	806625301
		3.5 mm orange	1.8 m	80663518*	806635181
			2.3 m	80663523*	806635231
			3.0 m	80663530*	806635301
			3.5 m	80663535*	806635351
		5.0 mm grey	2.3 m	80665023*	806650231
			3.0 m	80665030*	806650301
3.5 m			80665035*	806650351	

* The light cables can also be ordered without adapter.
Adapters for connecting products from other manufacturers are offered as separate items in our product range.

System blue

Fiber light cable

Fiber light cable blue	Color coding on endoscope side	Ø of fiber bundle and color code	Length	Fiber light cable without adapter Product no.	Complete Product no.
 Special fiber light cable, bndl Comprising: Fiber light cable, Adapter, projector side (8095.07), and adapter, endoscope side (809509)		3.5 mm orange	2.3 m	80673523	806735231

- Suitable for low-temperature procedure
- Steam-sterilizable
- Can be used in blue light and white light mode
- Highly flexible design
- Improved light transmission
- High-performance fiber optic material "made in Germany"
- Fast "snap-on" precision connection between endoscope and light cable
- System blue design with blue sheath
- Compatible with all Richard Wolf light sources

Adapter

for RICHARD WOLF light cables *Fusion* Design

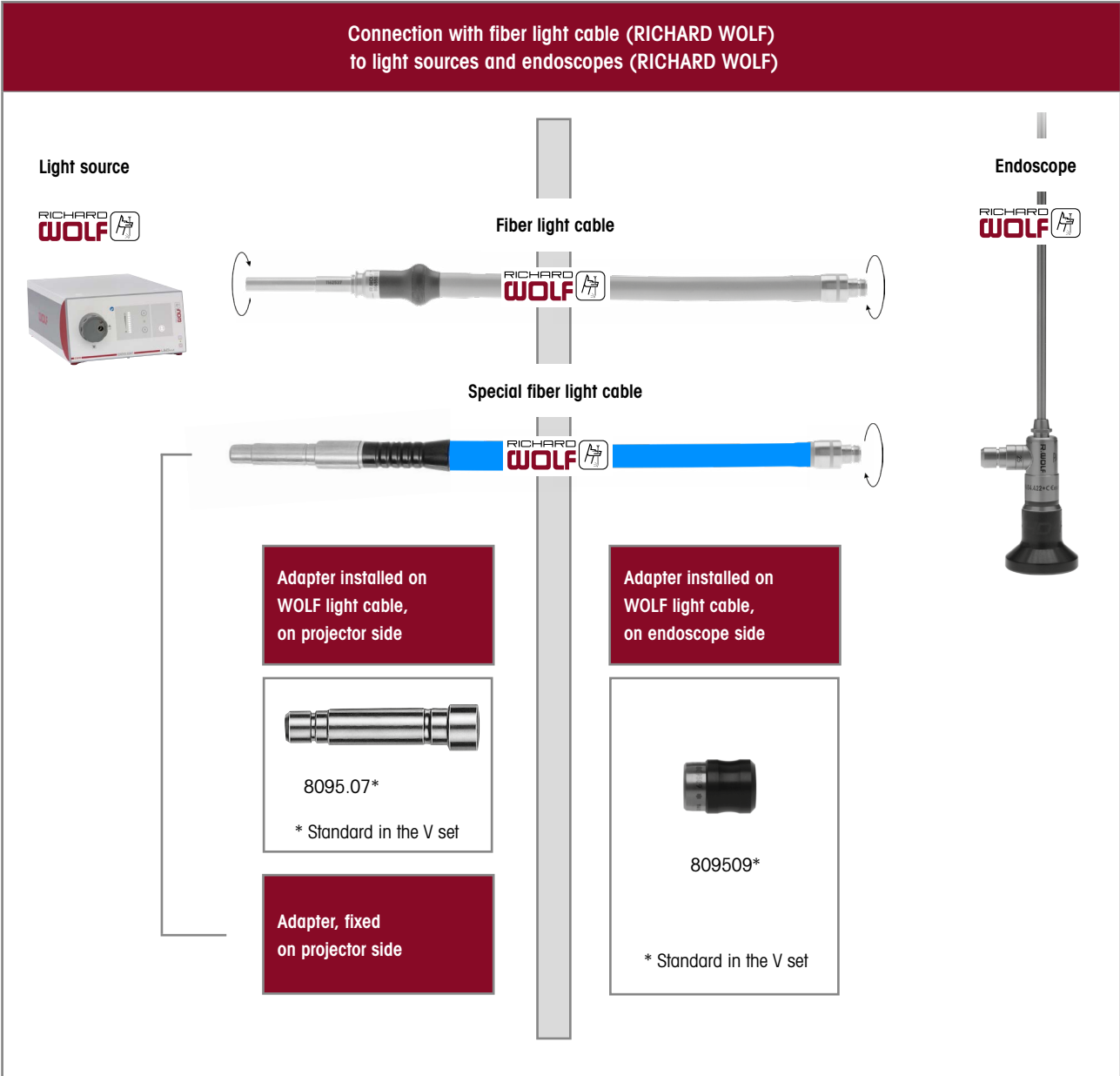

V19 || Subject to modifications. Please note that some products may not be available in all countries. For more detailed information, please consult with your contact partner or directly with Richard Wolf GmbH.

Adapter

for RICHARD WOLF light cables - *Fusion* Design

Connection with special fiber light cable (RICHARD WOLF) to light sources (RICHARD WOLF) and endoscopes (other manufacturers)

Light source



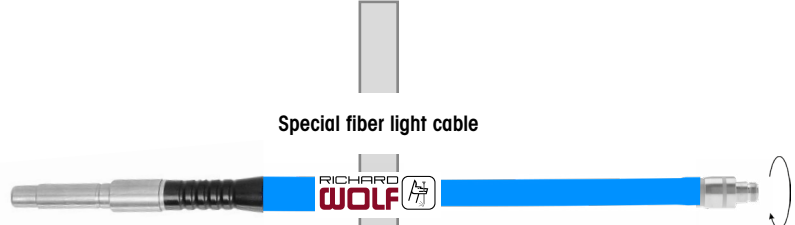

Special fiber light cable

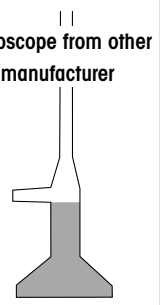

Endoscope from other manufacturer



Adapter installed on WOLF light cable, on projector side	Adapter, fixed on projector side	Adapter installed on WOLF light cable, on endoscope side	Endoscope made by:
		 807002	ACMI + Circon Henke-Hass-Wolf without adapter
			Storz without adapter
			Olympus without adapter
			Stryker without adapter
		 807001	ACMI + Circon Henke-Hass-Wolf
			Storz
			Olympus
			Stryker

V19 || Subject to modifications. Please note that some products may not be available in all countries. For more detailed information, please consult with your contact partner or directly with Richard Wolf GmbH.

Adapter

for RICHARD WOLF light cables

Connection with fiber light cable (RICHARD WOLF) to light sources and endoscopes (other manufacturers)

Light source from other manufacturer

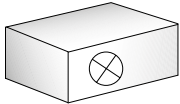



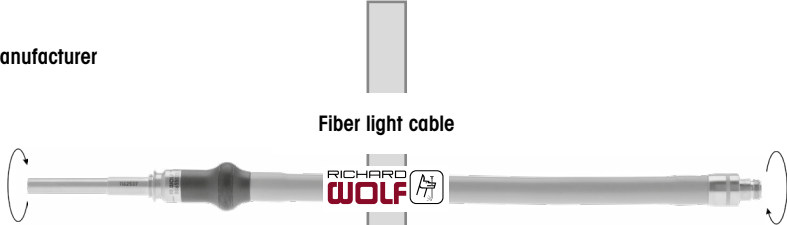

Fiber light cable

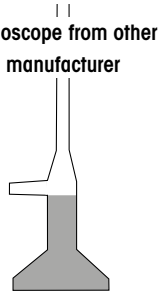

Endoscope from other manufacturer



Light source made by:	Adapter on projector side	Adapter on endoscope side	Endoscope made by:
Storz	fits directly	 807002	ACMI + Circon Henke-Hass-Wolf without adapter
Olympus	 8096.811		Storz without adapter
Stryker	 8095.07*		Olympus without adapter
* Standard in the V set			
		 807001	Stryker without adapter
			ACMI + Circon Henke-Hass-Wolf
			Storz
			Olympus
			Stryker

Adapter

for RICHARD WOLF light cables

Connection with fiber light cable (other manufacturer) to light sources and endoscopes (RICHARD WOLF)

Light source



Fiber light cable

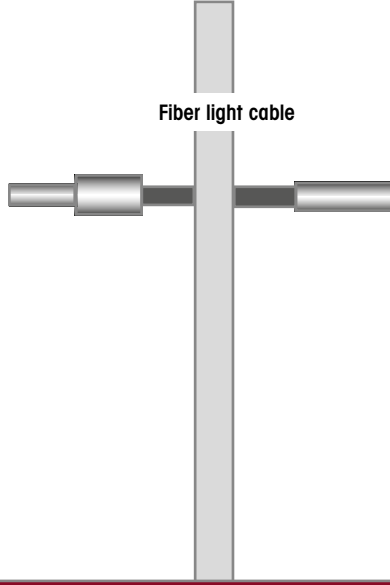





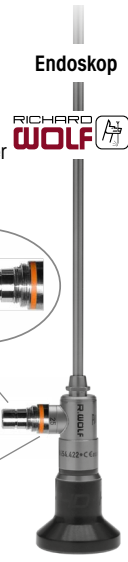

Endoscope

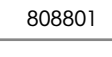

Endoskop



Adapter on projector side	Fiber light cable made by:	Adapter on endoscope side (without identification rings)	Adapter on endoscope side (with identification rings)
	Storz	 8088.00	 808801
	Olympus (standard)	 8088.80	 808801
	Olympus WA032...A	 8088.81	fits directly
	ACMI + Circon)	 8087.00	fits directly
	Stryker (clip-on)		fits directly
	Stryker (screw-on)		 808801

Evolution4K Recording System

Digitally records, stores, and archives 4K images and videos



- With one touch, simultaneously records 4K video and captures still images.
- Integrated 12.7 cm touch LCD screen provides intuitive menu navigation and quick setting changes.
- Work list function saves time by allowing cases to be added before they start.
- Records to internal hard drive and to USB 3.0 drives at the same time.
- Fulfills IT security standard by HIPAA compliance according to appropriate user management, system logging and data encryption. (HIPAA: Health Insurance Portability and Accountability Act to ensure the protection of patient data and health data).
- Printing via USB or networkprinter.
- 1 TB internal storage captures up to 40 hours of 4K UHD surgical footage.
- DICOM integration included: DICOM Worklist for automatic patient data import, DICOM Store for media storage.*
- DICOM transfer to archive: Automatic or manual activation, immediate transfer of the media or after closing the case.
- iOS wireless application (MedXStream App) for streaming, live still images, recording 4K video (via USB), surgical records and media review.

Evolution4K Recording System **EVO4K130**

Medical high-definition video recorder

* Connectivity is dependent on existing IT infrastructure.

Evolution4K Recording System

Technical data

Evolution4K Recording System	EVO4K130
Camera / video input resolutions	4K & 4K UHD: 4096x2160p & 3840x2160p, 50/60Hz HD: 1080p, 1080i, 720p
Video file format	AVCHD H.264 encoding .mp4 file format
Still file format	JPEG, PNG
Video inputs	1x HDMI 2.0
Video outputs	1x HDMI 2.0 loop through / pass through
Internal hard drive capacity	1 TB
Outputs for external touchpanels	VGA, DP++, HDMI (only 1 utilized at a time)
Ethernet ports	2x
3D compatibility	Yes, side by side or top / bottom (note: ENDOCAM Epic 3DHD not compatible, only with side by side converter)
Power supply	1 AC/DC medical grade power supply
Remote input	1x 3,5 mm record 1x 3,5 mm capture
USB	2x front side 4x rear side
Dimensions (W x H x D)	210 x 107 x 247 mm
Weight	2.72 kg (6 lbs.)

Sony UP-DR80MD Digital USB printer



- Compact high-quality printer with medical approval
- For PC applications and documentation systems
- Meaningful documentation of diagnostic findings with endoscopic images in HD quality
- Laminate coating on printing paper to protect the surface, resulting in longer storability
- Higher printing speed: A4 page in approx. 76 seconds
- Compact design and aesthetic shape
- Ideal for integration in RIWomobil device cart or for placing it at a nurse workplace

Digital color printer SONY UP-DR80MD 5651051

Color photo print package DIN-A4 UPC-R80MD 5651926
Paper roll for 50 printouts (2 pcs) and ink ribbon (2 pcs)

Technical data	
Device properties	
Printing system	Dye-sublimation printer
Resolution	301 dpi
Printing range (print package 5651926)	A4, 287 x 202 mm (11 3/4 x 8 inches), 3400 x 2392 dots
Printing speed	A4: approx. 76 seconds
Paper tray capacity	50 sheets
Interface	Hi-speed USB (2.0)
Power supply	
Power supply connection	100 - 240 VAC, 50 / 60 Hz
Current rating	3.4 to 1.4 A (max. 340 watts)
Regulatory standards	
Safety	IEC 60601-1, IEC 609950
Dimensions and weight	
Weight	approx. 11.5 kg
Dimensions (W x H x D)	317 x 207 x 425 mm

MEDICAPTURE

Digital Video and Image Memory

MediCap USB 300

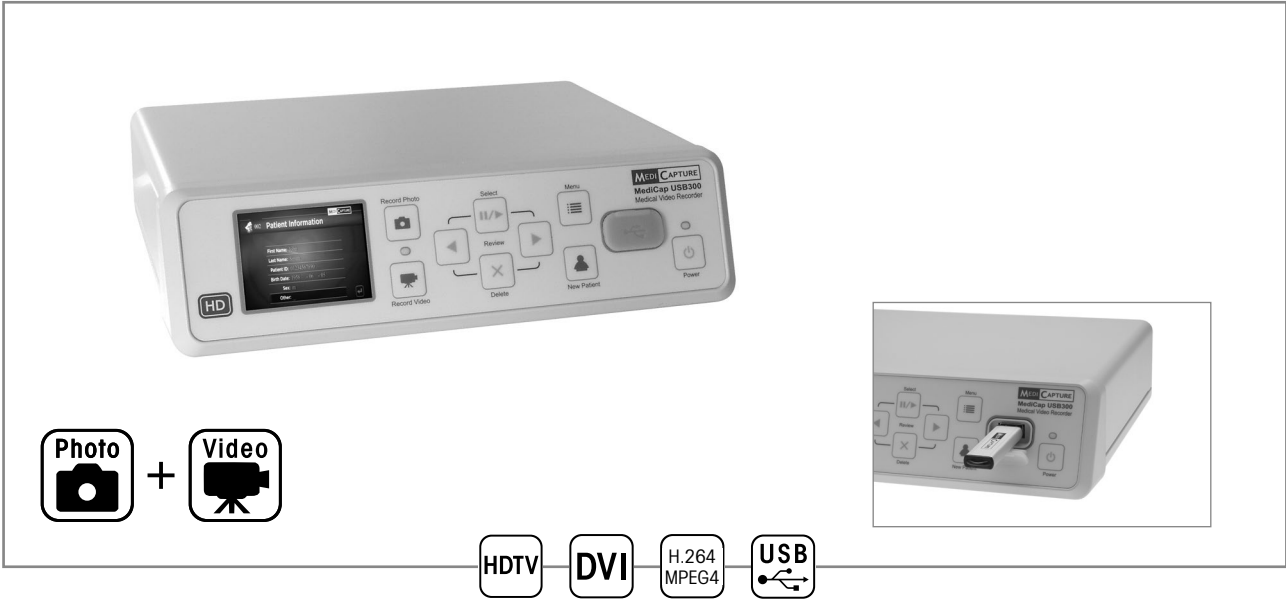

- Capture and storage of HD and HDTV film sequences and images on USB flash drives (USB sticks) and external USB hard disk
- Connection of external USB hard disks possible to expand the memory capacity up to 500 GB (= min. 150 hours of video in high-quality mode)
- Entry of patient data via USB keyboard
- MPEG4 compression of HD videos in format H.264 optimizes memory capacity requirements
- Compatible. Use with USB active devices (PC, laptop, etc.) and external USB hard disks (FAT 32 format)
- Remote control via camera head buttons
- Light color LCD display integrated on the device front panel to check stored images and navigate in the menu

MediCap USB 300 **5654006**

Medical high-definition video recorder
incl. USB flash-memory and cable accessories

Recommended accessories	Product no.
	USB flash memory 8 GB 56540028

MEDICAPTURE

Technical data

MediCap USB 300		5654006
Device properties		
Data formats	Single images JPEG, TIFF, BMP, DICOM Video: MPEG4, H.264 compression	
Recommended storage device	USB flash drive (min. 2 GB), USB hard disks (FAT 32 format)	
Operating conditions	-20°C to +40°C	
Network	Ethernet T 10 / 100 / 1000	
Equipment		
Internal hard disk	min. 320 GB	
LCD display	2.5" color monitor. Only for navigation – not for diagnostics!	
Power supply		
Mains + frequency	100 - 240 VAC, 50/60 Hz	
Regulatory standards		
Safety	EN 60601-1	
EMC	EN 60601-1-2	
Interfaces		
HD video standard	HDTV 720p / 1080i / 1080p, DVI up to 2048 x 1280	
SD video standard	PAL, NTSC	
HD signal input/output	HDSDI (1/1), DVI (1/1)	
Signal input	Video (BNC), S-Video (Y/C)	
Dimensions and weights		
Weight	approx. 1.8 kg	
Dimensions (W x H x D)	240 x 63 x 211 mm	

Universal device cart RIWomobil



All RIWomobil variants

have the following properties in common:

- Integrated cable duct
- 3 shelf units (width 370 mm), 2 of which continuously adjustable
- 4 double casters, 2 of which with dual-function locking (directional locking/freewheeling/full locking)
- Side profiles made of aluminum with mounting points for installing swivel arms and attaching a wide range of accessories
- Dimensions (W x H x D): 720 x 1518 x 700 mm
- 2 casters with dual conductivity
- Color: White, RAL 9016

RIWomobil features the following advantages:

- Order-specific production
Each cart is configured and built according to the customer's individual demands.
Any additionally selected shelf units and drawers are installed, adjusted and tested directly in the production process.
- Quality and value preservation
All components are designed for longevity and high loads.
- Safety
RIWomobil is a class 1 medical product and complies with directive 93/42 EEC.
All mechanical and electrical components are subjected to our permanent quality control process.
- Ergonomics
On all RIWomobil variants, the monitor position can be adapted to the demands of the operating team.
Height-adjustable shelf units and device handles on the cart provide individual adaptation options.

Universal device cart RIWomobil

Your optimum RIWomobil in just 3 steps

1. Where to place the monitors?

RIWomobil provides the option of positioning a swivel arm either in the center on the bridge or laterally in the side profile. As an alternative, a monitor mount can also be used to position a monitor in the center of the bridge.

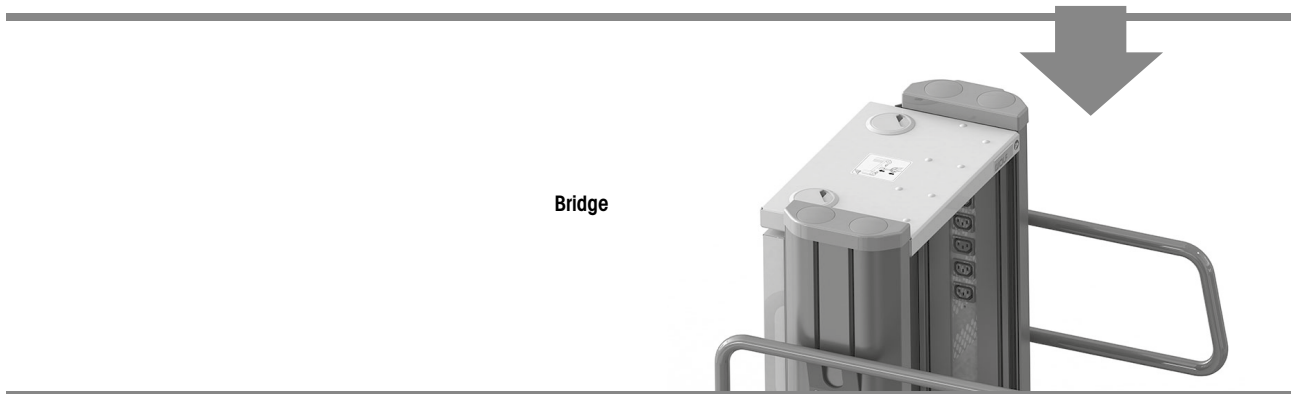

2. Which electrics variant?

The **baseline electrics with a main switch** integrated in the aluminum profile, distributor strip with 12 device connections. The **premium electrics variant for highest demands includes the following elements in addition to the baseline equipment**: isolating transformer and insulation monitoring unit with safety monitoring.

3. Which operating voltage?

RIWomobil with premium electrics

(for accessories, see section Device cart accessories)

Comprising:

Basic housing (premium version) with integrated isolating transformer, insulation monitoring unit, socket strip with main switch module, insulation monitor display and 12 sockets, 6 device connection cables, power cable 5.5 m,

Isolating transformer 220-230V, 2000VA **32116015**

Isolating transformer 100-120V, 1700VA **32116013**

RIWomobil with baseline electrics

(for accessories, see section Device cart accessories)

Comprising:

Basic housing (baseline version), socket strip with 12 sockets and integrated main switch module, 6 device connection cables, power cable 5.5 m,

Version with 220-240V, 2000VA **32116014**

Version with 100-120V, 1700VA **32116012**

RIWomobil without electrical equipment

For mounting swivel arms **32116011**

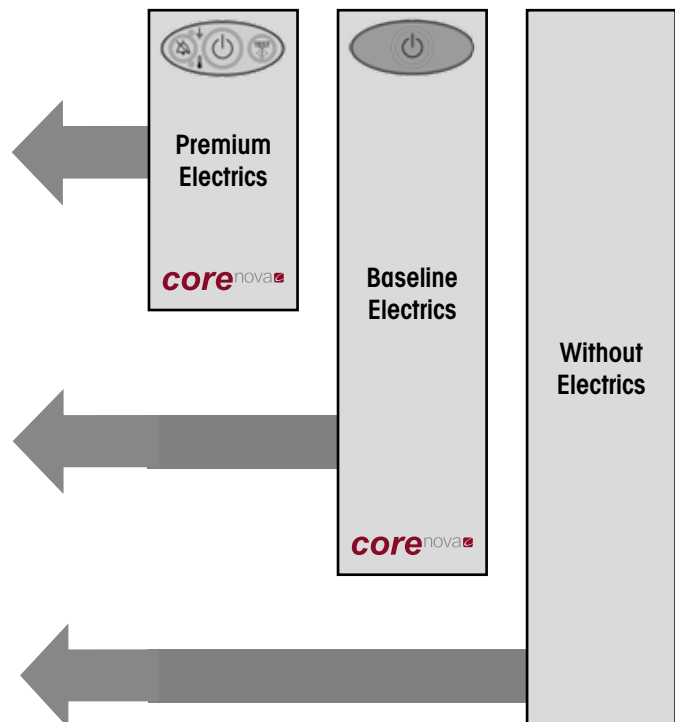



RIWomobil

Swivel arm on the side



All Flexion-Port models for mounting in the side profile have the following properties in common:

- VESA 100 mount
- Integrated cable duct
- Mechanical locking
- Swiveling range 340°. The area of the swiveling range can be defined individually during assembly
- Durable powder coating in white (RAL 9016)
- The specified length refers to the effective length between the swivel points
- Adapter for mounting in aluminum profile (32116473) is included in the set

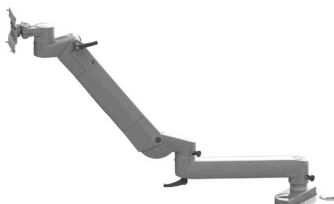

		Product no.
	<p>FLEXION-PORT 300 (58 cm) bndI Load capacity: 3 - 10 kg Comprising: 1x FLEXION-PORT 300 (58 cm) 32116058 1x swivel arm mount for profile 32116473</p>	321160581
	<p>FLEXION-PORT 400 (68 cm) bndI Load capacity: 8 - 14 kg Comprising: 1x FLEXION-PORT 400 (68 cm) 32116068 1x swivel arm mount for profile 32116473</p>	321160681
	<p>FLEXION-PORT 350+300 (93 cm) bndI Load capacity: 8 - 12 kg Comprising: 1x FLEXION-PORT 350+300 (93 cm) 32116093 1x swivel arm mount for profile 32116473</p>	321160931
	<p>FLEXION-PORT 350+400 (103 cm) bndI Load capacity: 3 - 9 kg Comprising: 1x FLEXION-PORT 350+400 (103 cm) 32116103 1x swivel arm mount for profile 32116473</p>	321161031

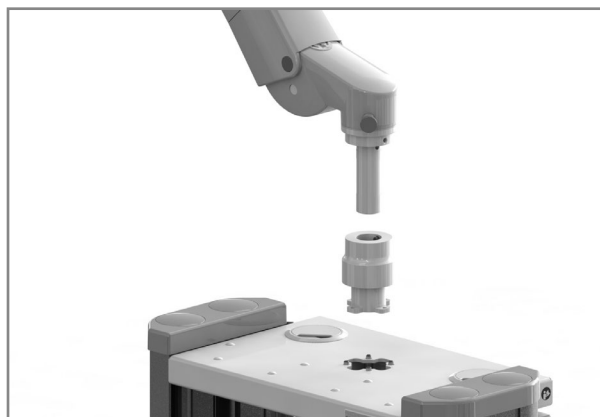
RIWomobil Swivel arm for bridge



All Flexion-Port models for mounting on the bridge have the following properties in common:

- VESA 100 mount
- Integrated cable duct
- Mechanical locking
- Swiveling range 340°. The area of the swiveling range can be defined individually during assembly
- Durable powder coating in white (RAL 9016)
- The specified length refers to the effective length between the swivel points
- Adapter for mounting on the bridge (32116474) is included in the set

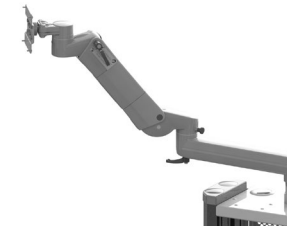
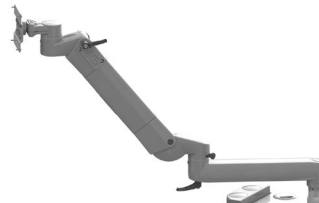

		Product no.
	<p>FLEXION-PORT 300 (58 cm) bndl Load capacity: 3 - 10 kg Comprising: 1x FLEXION-PORT 300 (58 cm) 32116058 1x swivel arm mount for bridge 32116474</p>	321160582
	<p>FLEXION-PORT 400 (68 cm) bndl Load capacity: 8 - 14 kg Comprising: 1x FLEXION-PORT 400 (68 cm) 32116068 1x swivel arm mount for bridge 32116474</p>	321160682
	<p>FLEXION-PORT 350+300 (93 cm) bndl Load capacity: 8 - 12 kg Comprising: 1x FLEXION-PORT 350+300 (93 cm) 32116093 1x swivel arm mount for bridge 32116474</p>	321160932
	<p>FLEXION-PORT 350+400 (103 cm) bndl Load capacity: 3 - 9 kg Comprising: 1x FLEXION-PORT 350+400 (103 cm) 32116103 1x swivel arm mount for bridge 32116474</p>	321161032

V19 || Subject to modifications. Please note that some products may not be available in all countries. For more detailed information, please consult with your contact partner or directly with Richard Wolf GmbH.

RIWomobil Accessories

The accessories listed on this page is available in two variants:

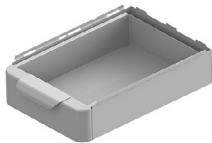
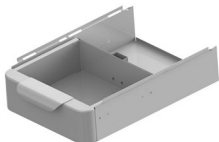
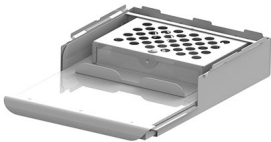
1. Mounting, adjustment and final check during the production process
2. Retrofit kit for assembly by customer

Drawers		Product no.
	Assembly during RIWomobil production Drawer	32116412
	Retrofit kit Drawer	321164121
	Assembly during RIWomobil production Drawer, short, with compartment for power supply unit	32116414
	Retrofit kit Drawer, short, with compartment for power supply unit	321164141
	Pull-out keyboard with mousepad	32116413
	Retrofit kit Pull-out keyboard with mousepad	321164131
Shelf unit to accommodate large devices		
 Dimensions: width: 370 mm, depth: 526 mm	Assembly during RIWomobil production Shelf unit	32116401
	Retrofit kit Shelf unit	321164011
 Dimensions: width: 370 mm, depth: 626 mm	Assembly during RIWomobil production Shelf unit, long	32116402
	Retrofit kit Shelf unit, long	321164021



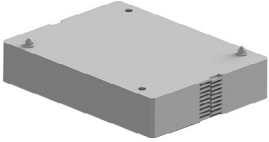
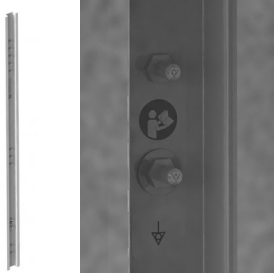

RIWomobil Accessories

The accessories listed on this page is available in two variants:

1. Mounting, adjustment and final check during the production process
2. Retrofit kit for assembly by customer

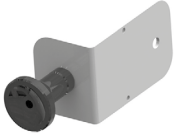
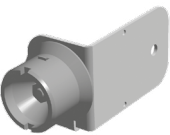
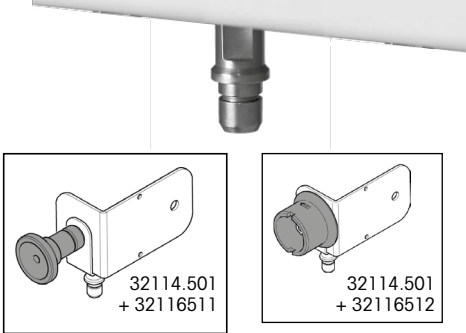
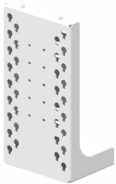
Balancing module to improve tip-over stability for the RIWomobil. Required when mounting swivel arm to RIWomobil 32116xxx without any electrical equipment		Product no.
	Assembly during RIWomobil production Balancing module	32116458
	Retrofit kit Balancing module	321164581
Balancing module to improve tip-over stability for the RIWomobil. Required when mounting swivel arm to RIWomobil 32116xxx with baseline electrics		
	Assembly during RIWomobil production Balancing module for baseline electrics	32116459
	Retrofit kit Balancing module for baseline electrics	321164591
Integrated equipotential bonding rail incl. 6 POAG device cables 0.8 m, 1 POAG supply line 6 m		
	Assembly during RIWomobil production POAG module	32116305
	Retrofit kit POAG module	321163051

RIWomobil
Accessories



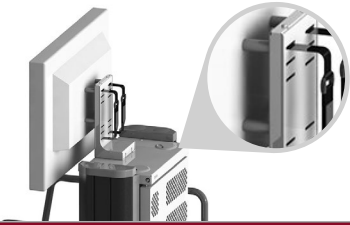
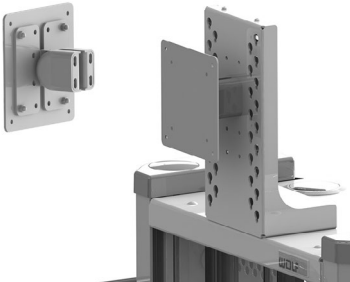
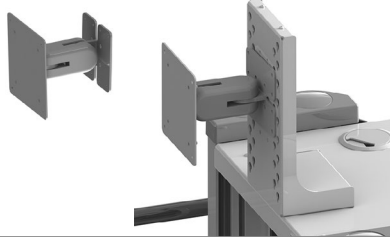
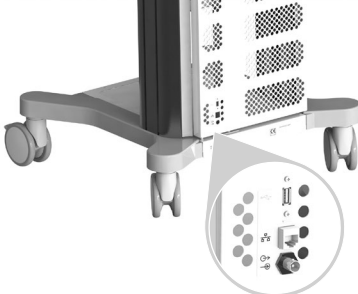
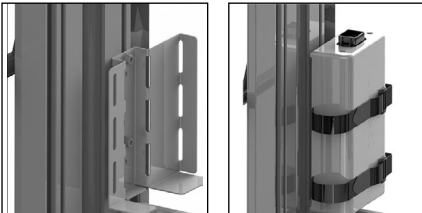

Camera holding bracket for universal use with standard and RIWO lenses		Product no.
	<p>Camera holding bracket</p> <p>For universal use with standard and RIWO lenses</p>	32116511
	<p>Camera holding bracket</p> <p>for mounting 3DHD camera heads</p>	32116512
Light cable holder for mounting light cables with R.Wolf connection		
	<p>Light cable holder</p>	32114501
Monitor mounting bracket		
 <p>Front view</p>  <p>Rear view</p>	<p>Monitor mounting bracket VESA 75 x 100</p> <p>Monitor mounting bracket for installation on the bridge.</p>	321165001
 <p>Front view</p>  <p>Rear view</p>	<p>Monitor mounting bracket VESA 200 x 400</p> <p>Monitor mounting bracket for installation on the bridge.</p>	32116472
	<p>Monitor mounting bracket, lateral, VESA 75/100</p> <p>incl. adapter plate for lateral installation on RIWomobil. Inclining or swiveling, maximum load: 15 kg, length: 5.5 cm</p>	32116451

RIWomobil Accessories

Spacer for monitors on VESA mounts		Product no.
	Spacer for monitors	64031002
Swivel adapter		
	<p>Swivel adapter VESA 75/100 short Inclining or swiveling, maximum load: 15 kg, length: 5.5 cm</p>	32116502
	<p>Swivel adapter VESA 75/100 Inclining and swiveling, maximum load: 15 kg, length: 11 cm</p>	32116501
Adapter		
	<p>Conn. USB, Ethernet, BNC Cable adapter for USB (incl. 0.5 m extension), RJ45 CAT.6A for Ethernet and BNC (for composite, SDI, HD-SDI and 3G-SDI)</p> <p><i>The feed-through adapter is attached to the rear panel of RIWomobil. Corresponding connections can remain hardwired inside the cart. External cable connections are simply plugged in to the rear of RIWomobil.</i></p>	32116701
Power supply unit bracket for mounting to side profile of RIWomobil		
	<p>Power supply unit bracket Incl. fixing material for various power supply unit sizes</p>	32116542



RIWomobil Accessories

Device carts

Infusion bottle holder		Product no.
	<p>Infusion bottle holder adjustable from 1.6 m to 2.6 m, load capacity max. 8 kg</p>	32114.521
CO ₂		
	<p>CO₂ bottle holder, 1 L for bottle ø up to max. 90 mm, load capacity max. 5 kg</p>	32114.531
	<p>CO₂ bottle holder, 10 L for bottle ø up to max. 160 mm, load capacity max. 35 kg</p>	32114.535
Lateral holder		
	<p>Holder for hand-held remote control or camera head connector</p>	64030.106
Footswitch tray and bracket		
	<p>Footswitch tray load capacity max. 3 kg</p>	32114.541
	<p>Universal holder load capacity max. 3 kg</p>	32114.545

V19 || Subject to modifications. Please note that some products may not be available in all countries. For more detailed information, please consult with your contact partner or directly with Richard Wolf GmbH.

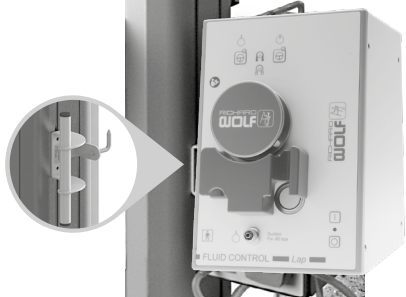
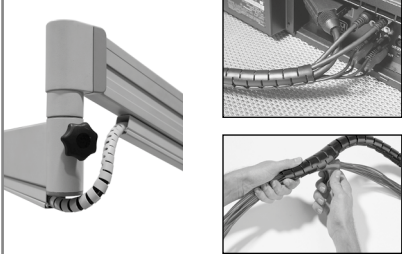
RIWomobil Accessories

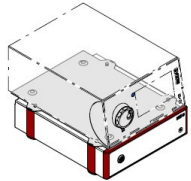
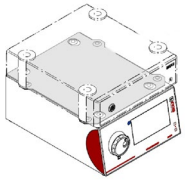
Universal holder 2216		Product no.
	<p>Universal holder 2216 for FLUID CONTROL LAP</p>	<p>32114.605</p>
Spiral tube set		
	<p>Spiral tube set for routing on swivel arms, length 2.0 m</p>	<p>74021.031</p>
Transport lock for securing R. Wolf electro-medical devices (width 300 mm)		
	<p>Transport lock</p>	<p>64267001</p>
Adapter plate for combining different housing series		
	<p>Adapter plate for housing cover 330 mm Housing 300 mm (narrow) to housing 330 mm (wide)</p>	<p>64164051</p>
	<p>Adapter plate for housing cover 300 mm Housing 330 mm (wide) to housing 300 mm (narrow)</p>	<p>64164052</p>

V19 || Subject to modifications. Please note that some products may not be available in all countries. For more detailed information, please consult with your contact partner or directly with Richard Wolf GmbH.

Rolling rack UNI-Cart



Equipment cart UNI-Cart **32113202**

Mechanically height-adjustable

■ **Device cart UNI-CART**

Base rack, monitor mount, handle, power supply unit bracket, IEC socket strip cable winder, power cable with Schuko plug and IEC socket, IEC cable

Device cart	32113202
Basic rack	with 4 double casters, Ø=100 mm
Monitor mount	VESA 75/100
Holding bracket for power supply unit	large, for supply units with max. 420 mm circumference
IEC socket strip	3 sockets with switch
IEC socket	Length 5 m
IEC cable	Length 1.5 m
max. load	14 kg
Adjustment range (VESA top edge)	1330 - 1630 mm, mechanically height-adjustable
Dimensions (W x H x D)	540 x 1690 x 580 mm

Monitor cart (trolley)



Monitor cart **32116000**

- 4 double casters, 2 of which with dual-function locking (directional locking/freewheeling/full locking)
- 2 electrically conductive casters
- Color: White, RAL 9016
- Dimensions (W x H x D): 720 x 1518 x 700 mm
- Empty weight: 43.5 kg
- Permissible total weight: 300 kg
- Without electrical accessories

Recommended accessories		Product no.
Monitor mounting bracket VESA 75 x 100	Compatible for 31" monitor	321165001
Monitor mounting bracket VESA 200 x 400	Compatible for 31" and 55" monitors	32116472
Balancing module	For advance assembly	32116458
Balancing module	For retrofitting	321164581
Power cable 5.5 m		244007
Velcro fastener belt 25 x 630		74015046